

# Webstone®

a brand of **NIBCO®**

## PRODUCT CATALOG



**THERMOSTATIC  
MIXING VALVES**

TWH SERVICE VALVES  
**E·X·P**  
SERIES

**GAS  
SEDIMENT  
TRAP**

**HYDRO-CORE**

**SYSTEM  
MANAGEMENT  
PRODUCTS**

**PRO-PAL**  
SERIES

**The ISOLATOR**  
UNI-FLANGE BALL VALVE®

**PRO-CONNECT  
PPRPRO**

**PRO-CONNECT  
PROPUSH**

**VALVES &  
FITTINGS**

**VALVE INNOVATION**  
**INSTALLATION SOLUTIONS**

# WORK SMARTER

WHERE WOULD YOU USE WEBSTONE?

SEE PAGE 26

## THERMOSTATIC MIXING VALVES

Thermostatic Mixing Valves	4
TMV Accessories	7
Ultra-Compact Thermostatic Mixing Valve	8
Water Heater Tempering Valve	9

## E-X-P® SERIES TANKLESS WATER HEATER KITS

E-X-P®	12
E2™	12
E3™	12
Ultra-Compact	13
Union Ball	13
E-X-P Accessories	13
Complete TWH Installation Kits	14

## GAS SEDIMENT TRAP

### HYDRO-CORE® & BOILER KITS

Hydro-Core Manifold	17
Hydro-Core Complete Near Boiler Piping Kits	18
Hydro-Core Union Connections	19
E-X-P Series Wall Hung & Combi Boiler Kits	19

## SYSTEM MANAGEMENT PRODUCTS

Air Separators	20
Magnetic Boiler Filters	22
Y-Strainers	23
Differential Pressure By-Pass Valves	24
Check Valves	24
G-Union Fittings & Accessories	25

## TERMS OF SERVICE

**FREIGHT ALLOWANCE:** Contact Customer Service at 800-225-9529 or [webstone@nibco.com](mailto:webstone@nibco.com).

**MINIMUM ORDER:** No minimum order when placed via NIBCO Partner or EDI Transmission. Orders submitted through other mediums are subject to a \$50 minimum.

**CLAIMS OF SHORTAGE OR VARIANCE:** Claims of any character must be made within 10 days after receipt of goods. Settlements of any claims are at the discretion of Webstone, a brand of NIBCO.

**RETURNS:** Webstone, a brand of NIBCO, reserves the right to charge a 30% restocking fee on any returned merchandise. Overstock returns for products that have been discontinued, redesigned, or purchased prior to the previous 12 months will not be accepted. Product returns will not be granted in November or December of any year unless such return is being made as a warranty return or in the event that an incorrect product was shipped. Purchase order or invoice numbers are required for all returns.

An issued Return Goods Authorization form is required for all product returns. No product returns less than \$100 will be accepted.

**ORDER CONFIRMATION:** All orders are subject to acceptance by Webstone, a brand of NIBCO. Prices are subject to change without notice.

**STANDARD PACKAGING:** Typically, shipments are made in case and carton quantities. However, Webstone, a brand of NIBCO, will ship any quantities ordered.

**UPC BARCODING:** 100% of products will be shipped with barcodes if customer specifies the need.

## PRO-PAL® SERIES

Ball Drain™	28
Ball Drain Strainer™	29
Union Ball Drain™	29
Union Ball™	30
T-Union Ball Drain™	30
T-Union Ball™	31
L-Union Ball™	31
Purge Tee™	32
T-Valve™	32
3-Way Ball Valves	33
Purge & Fill™	34
T-Drain™	34
Expansion Tank Pro Service Valve™	35
Add-A-Gauge Tool	35

## THE ISOLATOR®

Rotating Flange	36
Uni-Flange Ball Valve	37
Round Flange	38
Select	39
Double Flanged Check	39

## PRO-CONNECT™ PRODUCTS

Pro-Connect PP-R Pro™	40
Pro-Connect ProPush™	42

## VALVES & FITTINGS

Transition Fittings	44
Unions	45
Ball Valves	46
Transition Ball Valves	47
Specialty Ball Valves	47
Hose Drain Valves	48
Gate Valves	48

<b>INDEX</b>	49
--------------	----

### Third Party Approvals and Standards Organizations



**CSA Group**  
[www.csagroup.org](http://www.csagroup.org)

**IAPMO R&T**  
[www.iapmort.org](http://www.iapmort.org)



**Unless otherwise designated, lead-free certification (NSF/ANSI 61 & NSF/ANSI 372) was performed by Truesdail Laboratories.**  
[www.truesdail.com](http://www.truesdail.com)



**Certified to the Uniform Plumbing Code**

### Note:

Third Party Approval Agencies often can approve products to a wide variety of standards; some of the standards may be under the responsibility of another agency. For example, IAPMO can issue approvals to NSF/ANSI 61 standard, as can Truesdail, CSA, etc.

Product identified as being constructed of Lead-Free Brass have a maximum weighted average lead content of 0.25% of the wetted surface of the product in accordance with the requirements of the Reduction of Lead in Drinking Water Act.

Product identified as being constructed of standard brass have a lead content in excess of the 0.25% limit and are not to be used in potable water systems.

Pressure Relief Valve capacity ratings listed are the ASME National Board value.

### Definition of Terms

**CWP:** Cold Working Pressure: This designates the maximum non-shock operating pressure of the product. The "Cold" is defined as temperatures in the range from above freezing to 100°F. Above 100°F the maximum allowable pressure decreases as listed in the product specification sheet.

**WSP:** Working Steam Pressure: Indicates the maximum steam pressure of the product. This rating is independent from the CWP rating. The WSP rating is lower than the CWP rating.

# THERMOSTATIC MIXING VALVES

## RIGHT TEMPERATURE

## RIGHT CONNECTION

### FOUR TEMPERATURE RANGE OPTIONS

Provide versatility to accommodate different application and heat source requirements

- Mixes hot and cold water to pre-set output temperature
- Heavy duty lead-free forged brass construction
- Sizes 3/8" - 1"
- FIP, MIP, SWT, Push, Press, F1807 PEX, F1960 PEX connections
- Wide range of G-Union Accessories and Kits offer a solution for most installation needs

### EASY TEMPERATURE LOCKING HANDLE

Included on select models

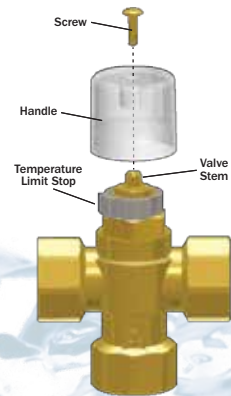

### G-UNION ACCESSORIES

Options include dual scale temperature gauge, isolation ball valves, and G-Union Isolators

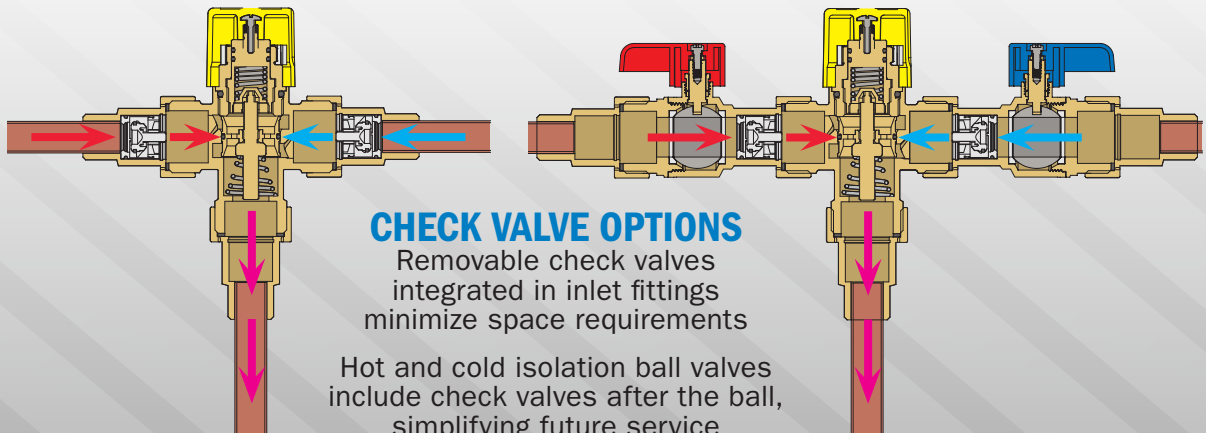

### CHECK VALVE OPTIONS

Removable check valves integrated in inlet fittings minimize space requirements

Hot and cold isolation ball valves include check valves after the ball, simplifying future service



# APPLICATIONS

## WATER DISTRIBUTION SYSTEMS

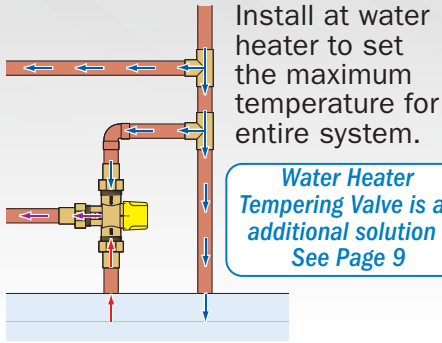

*Water Heater Tempering Valve is an additional solution - See Page 9*

## LOW TEMP HYDRONIC

Set a maximum temperature up to 131°F for radiant floor or other low temp heating application

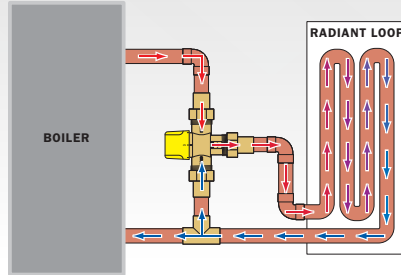

## HIGH TEMP HYDRONIC

Set a maximum temperature up to 176°F for radiant floor, baseboard heat, radiators, or other high temp heating application

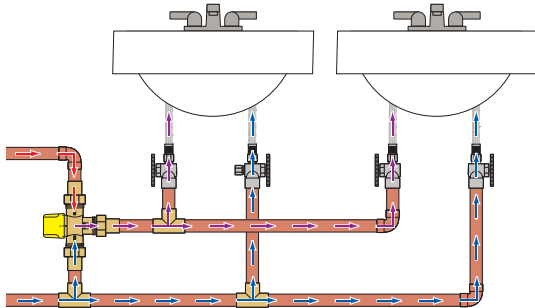
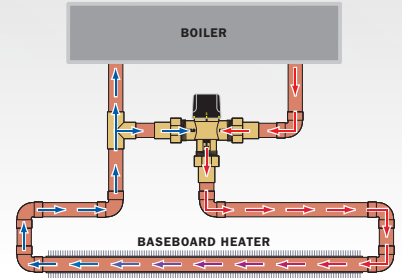

## POINT OF USE - MULTI FIXTURE

Set the maximum temperature for a group of fixtures

*Ultra-Compact TMV ideal for Single Fixture Point of Use - See Page 8*

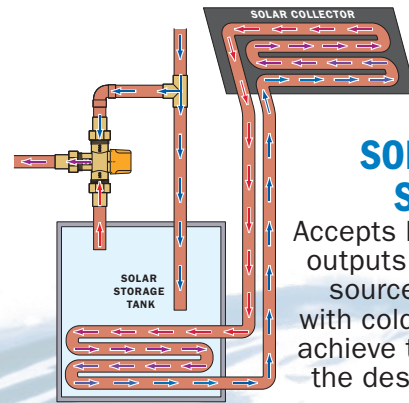

## SOLAR HEAT SOURCE

Accepts high temperature outputs from solar heat sources, then mixes with cold water supply to achieve temperatures for the desired application

# FOUR TEMPERATURE RANGES

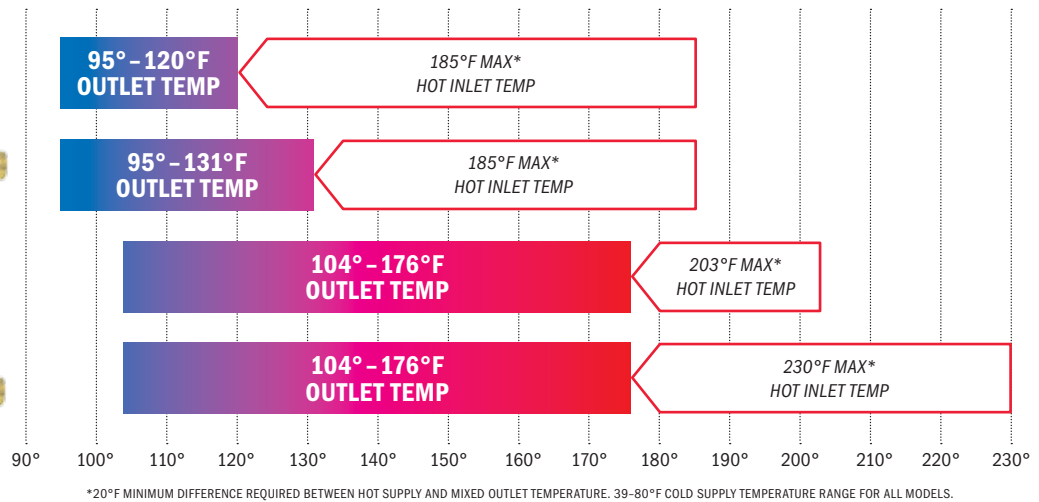

Customize your installation and simplify future service with a full selection of

## G-UNION ACCESSORIES & ISOLATION KITS

SEE PAGE 7 FOR DETAILS



# THERMOSTATIC MIXING VALVES

APPLICATION	WATER DISTRIBUTION SYSTEMS Certified to NSF/ANSI 61 & 372, ASSE 1017, CSA B125.3 - Body (H-7000W) certified by CSA to ASSE 1017		LOW TEMP HYDRONIC	HIGH TEMP HYDRONIC	SOLAR HEAT SOURCE	POINT OF USE		
	Certified to NSF/ANSI 61 & 372, ASSE 1017 - Body (H-7006W) certified by CSA to ASSE 1017				Certified to NSF/ANSI 61 & 372, ASSE 1017 & 1070, CSA B125.3	SINGLE ONLY Certified to NSF/ANSI 61 & 372, ASSE 1070		
MIXED OUTPUT TEMP RANGE	95° - 120°F (35° - 49°C)	95° - 131°F (35° - 55°C)	95° - 131°F (35° - 55°C)	104° - 176°F (40° - 80°C)	104° - 176°F (40° - 80°C)	95° - 120°F (35° - 49°C)	95° - 131°F (35° - 55°C)	95° - 120°F (35° - 49°C)
HOT INLET TEMP	185°F MAX	185°F MAX	185°F MAX	203°F MAX	230°F MAX	185°F MAX	185°F MAX	180°F MAX
FIP	7220W-CAN	7220W	7220W	7227W	7226W	-	-	-
MIP	7420W-CAN	7420W	7420W	7427W	7426W	7420W-CAN	7420W	-
SWT	7520W-CAN	7520W	7520W	7527W	7526W	7520W-CAN	7520W	-
PRESS	7820W-CAN	7820W	7820W	7827W	7826W	-	-	-
PUSH	7620W-CAN	7620W	7620W	-	-	-	-	7761W - See Page 8
COMPRESSION	-	-	-	-	-	-	-	7720W/7740W - See Page 8
F1960 PEX	7320W-CE-CAN	7320W-CE	7320W-CE	7327W	-	-	-	-
F1807 PEX	7120W-CAN	7120W	7120W	7127W	-	-	-	-

## THERMOSTATIC MIXING VALVE W/ INTEGRAL CHECK VALVES

Forged Brass Valve w/ DZR Brass Fittings & G1 Union Connections  
Outlet Temperature Range 95° - 120°F

### LEAD-FREE BRASS

SIZE	ITEM#	CTN/CASE	CASE WT
<b>FIP</b> 150 PSI CWP Max/185°F Max			
1/2"	H-72202W-CAN	1/10	21
3/4"	H-72203W-CAN	1/10	22
1"	H-72204W-CAN	1/10	24
<b>MIP</b> 150 PSI CWP Max/185°F Max			
1/2"	H-74202W-CAN	1/10	19
3/4"	H-74203W-CAN	1/10	19
1"	H-74204W-CAN	1/10	22
<b>SWT</b> 150 PSI CWP Max/185°F Max			
1/2"	H-75202W-CAN	1/10	19
3/4"	H-75203W-CAN	1/10	19
1"	H-75204W-CAN	1/10	20
<b>Press</b> 150 PSI CWP Max/185°F Max			
1/2"	H-78202W-CAN	1/10	19
3/4"	H-78203W-CAN	1/10	21
1"	H-78204W-CAN	1/10	22
<b>Push</b> 150 PSI CWP Max/185°F Max			
1/2"	H-76202W-CAN*	1/10	21
3/4"	H-76203W-CAN*	1/10	22
<b>F1960 PEX</b> 150 PSI CWP Max/185°F Max			
1/2"	H-73202W-CE-CAN	1/10	18
3/4"	H-73203W-CE-CAN	1/10	18
<b>F1807 PEX</b> 150 PSI CWP Max/185°F Max			
1/2"	H-71202W-CAN*	1/10	18
3/4"	H-71203W-CAN*	1/10	18
<b>BODY ONLY - INSTALL W/ (3) G-UNION FITTINGS</b>			
<b>G-Thread</b> 150 PSI CWP Max/185°F Max			
1"	H-70000W-CAN	1/10	12

\*NEW ITEM NUMBER - FORMERLY H-7320W-CAN SERIES  
†PUSH FITTINGS CERTIFIED TO ASSE 1061

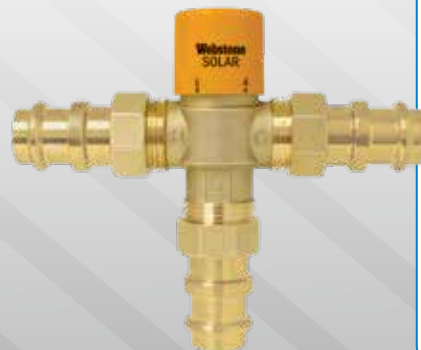

## THERMOSTATIC MIXING VALVE W/ INTEGRAL CHECK VALVES

Forged Brass Valve w/ DZR Brass Fittings, Temperature Locking Handle & G1 Union Connections  
Outlet Temperature Range 95° - 131°F

### LEAD-FREE BRASS

SIZE	ITEM#	CTN/CASE	CASE WT
<b>FIP</b> 150 PSI CWP Max/185°F Max			
1/2"	H-72202W	1/10	21
3/4"	H-72203W	1/10	22
1"	H-72204W	1/10	24
<b>MIP</b> 150 PSI CWP Max/185°F Max			
1/2"	H-74202W	1/10	19
3/4"	H-74203W	1/10	19
1"	H-74204W	1/10	23
<b>SWT</b> 150 PSI CWP Max/185°F Max			
1/2"	H-75202W	1/10	17
3/4"	H-75203W	1/10	19
1"	H-75204W	1/10	22
<b>Press</b> 150 PSI CWP Max/185°F Max			
1/2"	H-78202W	1/10	20
3/4"	H-78203W	1/10	21
1"	H-78204W	1/10	22
<b>Push</b> 150 PSI CWP Max/185°F Max			
1/2"	H-76202W*	1/10	21
3/4"	H-76203W*	1/10	22
<b>F1960 PEX</b> 150 PSI CWP Max/185°F Max			
1/2"	H-73202W-CE	1/10	18
3/4"	H-73203W-CE	1/10	18
<b>F1807 PEX</b> 150 PSI CWP Max/185°F Max			
1/2"	H-71202W*	1/10	18
3/4"	H-71203W*	1/10	18
<b>BODY ONLY - INSTALL W/ (3) G-UNION FITTINGS</b>			
<b>G-Thread</b> 150 PSI CWP Max/185°F Max			
1"	H-70000W	1/10	12

\*NEW ITEM NUMBER - FORMERLY H-7320W SERIES  
†PUSH FITTINGS CERTIFIED TO ASSE 1061

## THERMOSTATIC MIXING VALVE W/ INTEGRAL CHECK VALVES

Forged Brass Valve w/ DZR Brass Fittings, Temperature Locking Handle & G1 Union Connections  
Outlet Temperature Range 104° - 176°F

### LEAD-FREE BRASS

SIZE	ITEM#	CTN/CASE	CASE WT
<b>FIP</b> 150 PSI CWP Max/203°F Max			
1/2"	H-72272W	1/10	21
3/4"	H-72273W	1/10	22
1"	H-72274W	1/10	24
<b>MIP</b> 150 PSI CWP Max/203°F Max			
1/2"	H-74272W	1/10	19
3/4"	H-74273W	1/10	19
1"	H-74274W	1/10	23
<b>SWT</b> 150 PSI CWP Max/203°F Max			
1/2"	H-75272W	1/10	17
3/4"	H-75273W	1/10	19
1"	H-75274W	1/10	22
<b>Press</b> 150 PSI CWP Max/203°F Max			
1/2"	H-78272W	1/10	20
3/4"	H-78273W	1/10	21
1"	H-78274W	1/10	22
<b>F1960 PEX</b> 150 PSI CWP Max/203°F Max			
1/2"	H-73272W	1/10	18
3/4"	H-73273W	1/10	18
<b>F1807 PEX</b> 150 PSI CWP Max/203°F Max			
1/2"	H-71272W	1/10	18
3/4"	H-71273W	1/10	18
<b>BODY ONLY - INSTALL W/ (3) G-UNION FITTINGS</b>			
<b>G-Thread</b> 150 PSI CWP Max/203°F Max			
1"	H-70070W	1/10	12

## THERMOSTATIC MIXING VALVE W/ INTEGRAL CHECK VALVES









Forged Brass Valve w/ DZR Brass Fittings, Temperature Locking Handle & G1 Union Connections  
For Solar Applications - Max Input 230°F  
Outlet Temperature Range 104° - 176°F

### LEAD-FREE BRASS

SIZE	ITEM#	CTN/CASE	CASE WT
<b>FIP</b> 150 PSI CWP Max/230°F Max			
1/2"	H-72262W	1/10	21
3/4"	H-72263W	1/10	22
1"	H-72264W	1/10	24
<b>MIP</b> 150 PSI CWP Max/230°F Max			
1/2"	H-74262W	1/10	19
3/4"	H-74263W	1/10	19
1"	H-74264W	1/10	23
<b>SWT</b> 150 PSI CWP Max/230°F Max			
1/2"	H-75262W	1/10	17
3/4"	H-75263W	1/10	19
1"	H-75264W	1/10	22
<b>Press</b> 150 PSI CWP Max/230°F Max			
1/2"	H-78262W	1/10	20
3/4"	H-78263W	1/10	21
1"	H-78264W	1/10	22
<b>BODY ONLY - INSTALL W/ (3) G-UNION FITTINGS</b>			
<b>G-Thread</b> 150 PSI CWP Max/230°F Max			
1"	H-70060W	1/10	12

# TMV ISOLATION KITS

- Isolates TMV body for service
- Versatile combinations cover most TMV installations
- Easily re-arrange color-coded handles/check valves to valve bodies in accordance with system needs
- Compatible with G-Union Connections

	ISOLATION BALL VALVE			ANGLED ISOLATION BALL VALVE			The ISOLATOR <sup>®</sup> UNI-FLANGE BALL VALVE	
	 w/ Reversible Yellow Handle	 w/ Integral Check Valve & Reversible Red Handle	 w/ Integral Check Valve & Reversible Blue Handle	 w/ Reversible Yellow Handle	 w/ Integral Check Valve & Reversible Red Handle	 w/ Integral Check Valve & Reversible Blue Handle	 w/ Rotating Flange	 w/ Rotating Flange & Multi-Function Drain
H-7-G234W-KITA		✓	✓					
H-7-G234W-A-KITA					✓	✓		
H-7-G234W-KITB	✓	✓	✓					
H-7-G234W-A-KITB	✓				✓	✓		
H-7-G234W-KITD		✓	✓	✓				
H-G1404W-KITB		✓	✓				✓	
H-G1404W-A-KITB					✓	✓	✓	
H-G1414W-KITB		✓	✓					✓
H-G1414W-A-KITB					✓	✓		✓

## TMV G-UNION ACCESSORIES



**ISOLATION BALL VALVE**  
Full Port Forged DZR Brass Valve

**LEAD-FREE BRASS**  
Certified to NSF/ANSI 61 & 372

SIZE	ITEM#	CTN/CASE
G-Union × G-Thread	150 PSI CWP Max	
<b>W/ REVERSIBLE YELLOW HANDLE</b>		
1"	H-7-G134WY	10/60
<b>W/ INTEGRAL CHECK VALVE &amp; REVERSIBLE RED HANDLE</b>		
1"	H-7-G234WR	10/60
<b>W/ INTEGRAL CHECK VALVE &amp; REVERSIBLE BLUE HANDLE</b>		
1"	H-7-G234WB	10/60



**ISOLATOR W/ ROTATING FLANGE**  
Full Port Forged DZR Brass Uni-Flange Ball Valve - w/ Detachable Rotating Flange, Adjustable Packing Gland, Nuts & Bolts

**LEAD-FREE BRASS**  
Certified to NSF/ANSI 61 & 372

SIZE	ITEM#	HV ITEM#	CTN/CASE
G-Union × Rotating Flange	600 PSI CWP Max		
1"	H-G1404W	H-G1404WHV	1/20
<b>W/ MULTI-FUNCTION HI-FLOW HOSE DRAIN</b>			
1"	H-G1414W	H-G1414WHV	1/20

HV ITEMS FIT HIGH VELOCITY & STANDARD SIZE PUMPS.



**DUAL SCALE TEMPERATURE GAUGE**  
w/ Integrated Forged Brass Fitting - 1/2" Dial Temperature Range 32° - 248°F

**LEAD-FREE BRASS**  
Certified to NSF/ANSI 61 & 372

SIZE	ITEM#	CTN/CASE
G-Union × G-Thread		
1"	H-32000W	10/100



**ANGLED ISOLATION BALL VALVE**  
Full Port Forged DZR Brass Valve

**LEAD-FREE BRASS**  
Certified to NSF/ANSI 61 & 372

SIZE	ITEM#	CTN/CASE
G-Union × G-Thread	150 PSI CWP Max	
<b>W/ REVERSIBLE YELLOW HANDLE</b>		
1"	H-7-G134WY-A	10/60
<b>W/ INTEGRAL CHECK VALVE &amp; REVERSIBLE RED HANDLE</b>		
1"	H-7-G234WR-A	10/60
<b>W/ INTEGRAL CHECK VALVE &amp; REVERSIBLE BLUE HANDLE</b>		
1"	H-7-G234WB-A	10/60



**G1 UNION ELBOW**  
Forged DZR Brass Fitting

**LEAD-FREE BRASS**  
Certified to NSF/ANSI 61 & 372

SIZE	ITEM#	CTN/CASE
G-Union × G-Thread	150 PSI CWP Max	
1"	H-7-G144W-A	10/60

### HIGH-TEMP CHECK VALVES

Replaces included in-line check valves when using select isolation ball valves with high-temp solar heat sources









**SET OF 2 IN-LINE CHECK INSERTS & RETAINING RINGS**  
For Use With Webstone G1 Fittings For Solar Applications - Max Input 230°F

SIZE	ITEM#	CTN/CASE
150 PSI CWP Max/230°F Max		
3/4"	H-C7-303	10/100

### G-UNION FITTINGS

Pair with body-only TMVs or other union accessories to eliminate additional adapters or accommodate other unique installation needs

G-UNION SIZE	SYSTEM PIPING	FIP	MIP	SWT	Press	Push	F1960 PEX	F1807 PEX
								
<b>Forged DZR Brass Fitting</b>								
1"	1/2"	H-7-2102W WP	H-7-4102W WP	H-7-5102W WP	H-7-8102W WP	H-7-6102W WP	H-7-3102W WP	H-7-1102W WP
1"	3/4"	H-7-2103W WP	H-7-4103W WP	H-7-5103W WP	H-7-8103W WP	H-7-6103W WP	H-7-3103W WP	H-7-1103W WP
1"	1"	H-7-2104W WP	H-7-4104W WP	H-7-5104W WP	H-7-8104W WP	-	-	-
<b>Forged DZR Brass Fitting with Integral Check Valve</b>								
1"	1/2"	H-7-2202W WP	H-7-4202W WP	H-7-5202W WP	H-7-8202W WP	H-7-6202W WP	H-7-3202W WP	H-7-1202W WP
1"	3/4"	H-7-2203W WP	H-7-4203W WP	H-7-5203W WP	H-7-8203W WP	H-7-6203W WP	H-7-3203W WP	H-7-1203W WP
1"	1"	H-7-2204W WP	H-7-4204W WP	H-7-5204W WP	H-7-8204W WP	-	-	-



# ULTRA-COMPACT THERMOSTATIC MIXING VALVE

- Ultra-compact 2½" × 3¼" body
- Ideal for discrete under sink installations
- 95 – 120°F output range with locking handle, factory preset at 120°F
- Integral check valves and strainers on inlets
- Available accessories include elbow, tee, and 20 – 220°F dual-scale temperature gauge
- Includes mounting bracket
- DZR brass or bronze body options

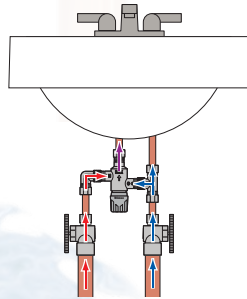
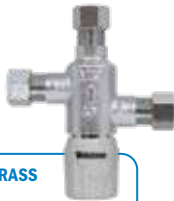

## POINT-OF-USE - SINGLE FIXTURE

Set the maximum temperature of each fixture individually

### CHROME-PLATED FORGED DZR BRASS THERMOSTATIC MIXING VALVE

For Point-of-Use (Single Fixture)  
Outlet Temperature Range 95° - 120°F

#### LEAD-FREE BRASS

Certified to NSF/ANSI 61 & 372, ASSE 1070

SIZE	ITEM#	CTN/CASE	CASE WT
<b>Compression</b>	150 PSI CWP Max/180°F Max		
3/8"	H-77201W	10/60	31
<b>W/ TEMPERATURE GAUGE</b>			
3/8"	H-77201W-TG	10/60	40
<b>W/ TEE FITTING</b>			
3/8"	H-77201W-T	10/60	39
<b>W/ TEE &amp; ELBOW FITTINGS</b>			
3/8"	H-77211W	10/60	44
<b>W/ TEMPERATURE GAUGE, TEE, &amp; ELBOW</b>			
3/8"	H-77211W-TG	10/60	53

### CHROME-PLATED FORGED DZR BRASS THERMOSTATIC MIXING VALVE

For Point-of-Use (Single Fixture)  
Outlet Temperature Range 95° - 120°F

#### LEAD-FREE BRASS

Certified to NSF/ANSI 61 & 372, ASSE 1061 - Fittings H-77610x, (Body H-77201W - NSF 61-372 & ASSE 1070)

SIZE	ITEM#	CTN/CASE	CASE WT
<b>Push</b>	150 PSI CWP Max/180°F Max		
1/4"	H-77610W	10/60	44
<b>W/ TEE &amp; ELBOW FITTINGS</b>			
1/4"	H-77610W-TG	10/60	53



### CHROME-PLATED FORGED DZR BRASS FITTINGS

For Use with Ultra-Compact TMV

#### LEAD-FREE BRASS

Certified to NSF/ANSI 61 & 372

SIZE	ITEM#	CTN/CASE	CASE WT
<b>TEE, ELBOW, &amp; CAP</b>			
<b>Compression</b>	150 PSI CWP Max		
3/8"	H-7-7211W WP	5/50	3
<b>1" DIAL 20 - 220°F TEMPERATURE GAUGE</b>			
<b>Compression</b>	150 PSI CWP Max		
3/8"	H-33000W	10/100	16



### CHROME-PLATED DZR BRONZE THERMOSTATIC MIXING VALVE

For Point-of-Use (Single Fixture)  
Outlet Temperature Range 95° - 120°F

#### LEAD-FREE

Certified to NSF/ANSI 61 & 372, ASSE 1070

SIZE	ITEM#	CTN/CASE	CASE WT
<b>Compression</b>	150 PSI CWP Max/180°F Max		
3/8"	H-77401W	10/60	31
<b>W/ TEMPERATURE GAUGE</b>			
3/8"	H-77401W-TG	10/60	40
<b>W/ TEE &amp; ELBOW FITTINGS</b>			
3/8"	H-77411W	10/60	44
<b>W/ TEMPERATURE GAUGE, TEE, &amp; ELBOW</b>			
3/8"	H-77411W-TG	10/60	53



### CHROME-PLATED FORGED DZR BRASS FITTINGS & Removal Tool · For Use with Ultra-Compact TMV

#### LEAD-FREE BRASS

Certified to NSF/ANSI 61 & 372, ASSE 1061

SIZE	ITEM#	CTN/CASE	CASE WT
<b>Push</b>	150 PSI CWP Max		
1/4"	H-7-7610W WP	5/50	3
<b>W/ TEMPERATURE GAUGE</b>			
1/4"	H-7-7610W-TG WP	5/50	7



# WATER HEATER TEMPERING VALVE

## HOT WATER MADE BETTER

**GREATER & SAFER HOT WATER OUTPUT PER GALLON STORED**

- Allows water heater to be set at 140°F, minimizing risk of Legionella bacteria in the tank
- Mixes hot output with cold supply for greater effective hot water storage
- Adjustable temperature control limits output to 120°F to prevent risk of scalding
- Integrated recirculation port simplifies installation



### TEMPERING BY-PASS VALVE

Provides high-temp untempered water to appliances

**WATER HEATER TEMPERING BY-PASS VALVE**  
Forged DZR Brass Valve w/ 1/2 Plugged FIP Port  
For Direct Connection to High-Temp Appliance

#### LEAD-FREE BRASS

Certified to NSF/ANSI 61 & 372

SIZE	ITEM#	CTN/CASE	CASE WT
G-Union x FIP 3/4"	H-G0673W	150 PSI CWP Max/194°F Max 6/48	34



### WATER HEATER TEMPERING VALVE

Forged DZR Brass Valve w/ 18" Flex Hose Connector  
& Integral Check Valves  
Outlet Temperature Range 86°-120°F

#### LEAD-FREE BRASS

Certified to NSF/ANSI 61 & 372, ASSE 1017 & 1070

SIZE	ITEM#	CTN/CASE	CASE WT
MIP x FIP 3/4"	H-74303W	150 PSI CWP Max/194°F Max 1/9	22
<b>W/ TEMPERATURE GAUGE</b>			
MIP x FIP 3/4"	H-74313W	1/9	26
Press x FIP 3/4"	H-78313W	1/9	26

### WATER HEATER TEMPERING VALVE W/ TEMPERATURE GAUGE & BY-PASS

Forged DZR Brass Valve, w/ 18" Flex Hose Connector,  
Temperature Gauge, Integral Check Valves & Tempering  
By-Pass Valve · Outlet Temperature Range 86°-120°F

#### LEAD-FREE BRASS

Certified to NSF/ANSI 61 & 372, ASSE 1017 & 1070

SIZE	ITEM#	CTN/CASE	CASE WT
MIP x FIP 3/4"	H-74323W	150 PSI CWP Max/194°F Max 1/9	33
Press x FIP 3/4"	H-78323W	1/9	33

### SIMPLIFY THE JOB

Tempering Valve Installation Kits include everything to connect to Copper, CPVC or PEX



**PRO-CONNECT  
PROPUSH**

### WATER HEATER TEMPERING VALVE INSTALLATION KIT

Forged DZR Brass Valve w/ 18" Flex Hose  
Connector, Integral Check Valves & (2) 3/4"  
ProPush Flexible Water Heater Connectors

#### LEAD-FREE BRASS

Certified to NSF/ANSI 61 & 372, ASSE 1017/1070  
& 1061, ASME A112.18.6, CSA B125.6

SIZE	ITEM#	CTN/CASE	CASE WT
<b>INCLUDES (2) 3/4" PROPUSH ITEM# H-26033W-18 FLEXIBLE WATER HEATER CONNECTORS</b>			
3/4"	H-74303W-KITA	1/4	14
<b>w/ Outlet Temperature Gauge</b>			
3/4"	H-74313W-KITA	1/4	19
<b>INCLUDES (2) 3/4" PROPUSH ITEM# H-62033W-18 FLEXIBLE WATER HEATER CONNECTORS W/ BALL VALVES</b>			
3/4"	H-74303W-KITB	1/4	16
<b>w/ Outlet Temperature Gauge</b>			
3/4"	H-74313W-KITB	1/4	21

# TWH SERVICE VALVES E·X·P<sup>®</sup> S E R I E S

## THE **ONLY** WAY TO INSTALL ANY **TANKLESS WATER HEATER**

PATENTED TECHNOLOGY

- Quicker, consistent quality installations
- Fewer leak paths
- Allows for one person diagnostic testing
- Full range of service valves styles, installation kits, and accessories
- Also for use with wall hung and combi boilers - see page 19
- EXP Complete kits include your choice of TWH service valves with pressure relief valve, integrated gas sediment trap, gas ball valve, and gas flex line

### SIMPLIFIES SERVICE

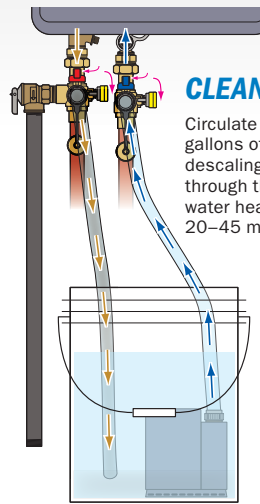

#### CLEANING

Circulate 3–5 gallons of flushing/descaling solution through the tankless water heater for 20–45 minutes.

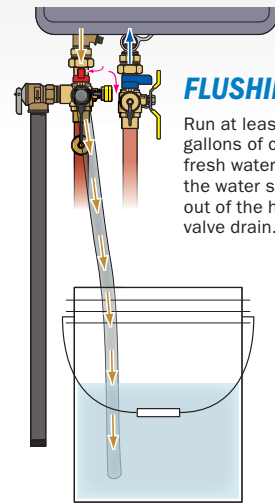

#### FLUSHING

Run at least 20 gallons of clean, fresh water from the water supply out of the hot valve drain.

TWH SERVICE VALVES  
**E·X·P**  
COMPLETE



### FULL RANGE OF SERVICE VALVES STYLES



TWH SERVICE VALVES  
**E·X·P**  
PREMIUM DESIGN



TWH SERVICE VALVES  
**E·X·P E2**  
SPACE SAVING



TWH SERVICE VALVES  
**E·X·P E3**  
ADJUSTABLE PRV PORT



TWH SERVICE VALVES  
**E·X·P**  
ULTRA-COMPACT



TWH SERVICE VALVES  
**E·X·P**  
UNION BALL

### IDEAL FOR INTEGRATED RECIRCULATION PORT CONNECTIONS



SEE PAGE 29

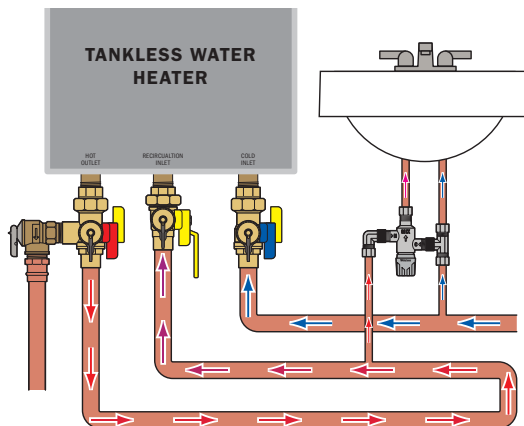

### PRESSURE RELIEF VALVE OPTIONS



**RESIDENTIAL PRV**  
150 PSI/500,000 BTU/HR  
PR Kits: Standard Brass  
PR-LF Kits: Lead-Free Brass



**COMMERCIAL PRV**  
150 PSI/2.7M BTU/HR  
w/ Close Nipple



**BOILER PRV**  
30 PSI/510,000 BTU/HR for  
Boiler/Hydronic Applications  
(see page 19)

**THE OLD WAY**

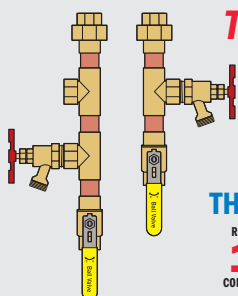

**THE WEBSTONE WAY**

REPLACES	SAVES	ELIMINATES
<b>14</b>	<b>108</b>	<b>12</b>
COMPONENTS	MINUTES	LEAK PATHS

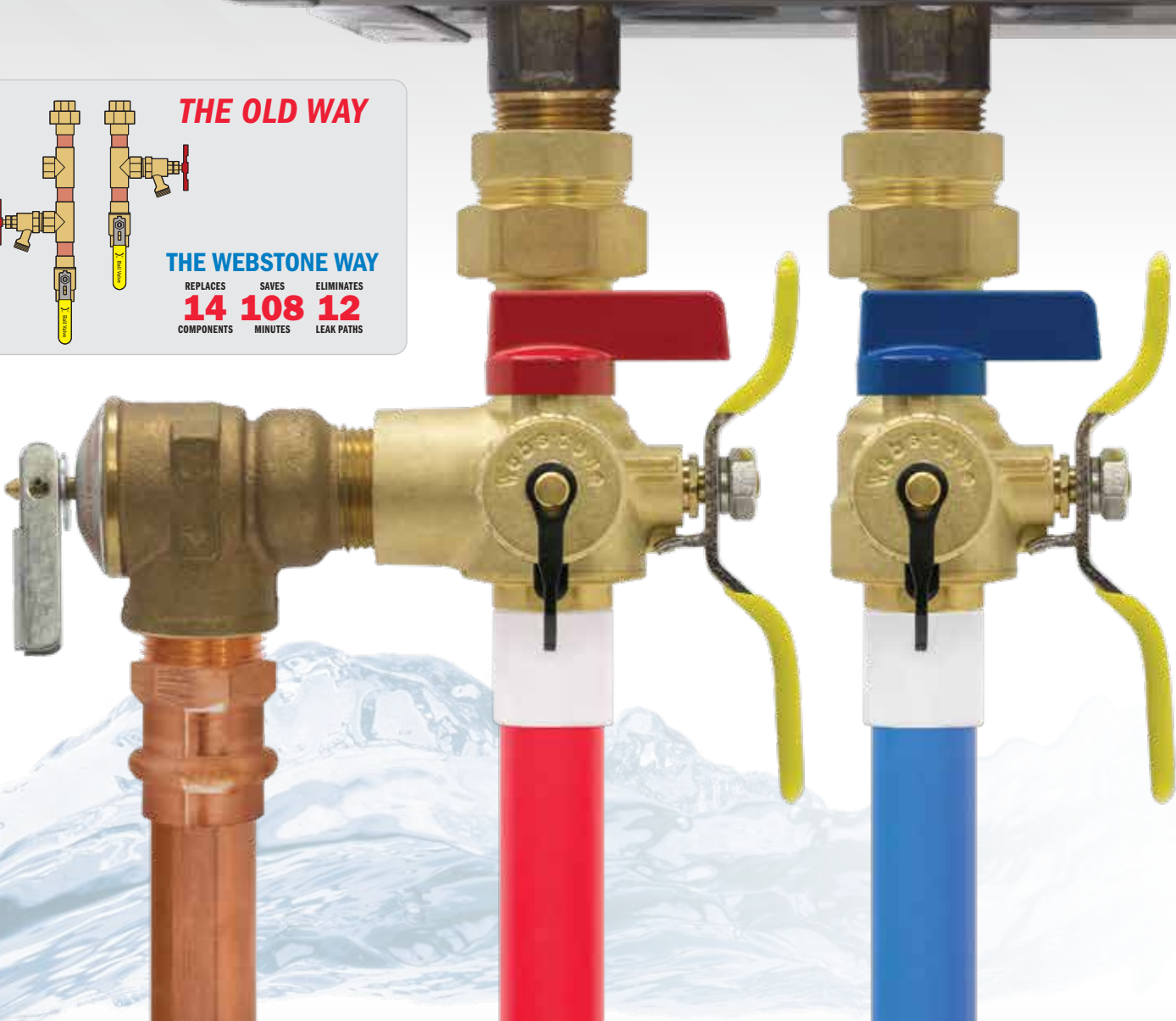

**OPTIONS FOR NEXT GENERATION TANKLESS SOLUTIONS**

TWH SERVICE VALVES  
**E·X·P·E2**  
SPACE SAVING

*No PRV port models for appliances with integrated PRV Ports.*



TWH SERVICE VALVES  
**E·X·P**  
UNION BALL

*For appliances with integrated PRV and drain ports*

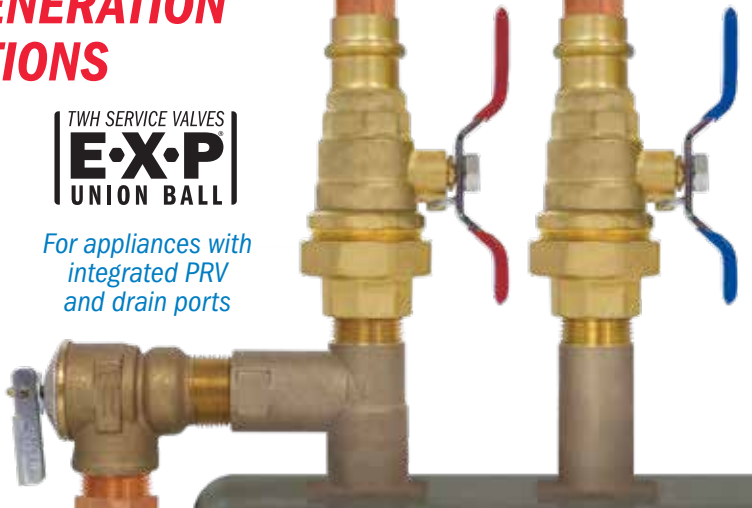





**E-X-P TANKLESS WATER HEATER SERVICE VALVE KIT**

Hot & Cold Set of Full Port Forged Brass Ball Valves w/ Hi-Flow Hose Drains, Pressure Relief Valve Outlet & Adjustable Packing Glands

**LEAD-FREE BRASS**

Certified to NSF/ANSI 61 & 372

SIZE	ITEM#	CTN/CASE	CASE WT
<b>FIP Union × FIP</b>		600 PSI CWP Max	
3/4"	H-40443W	1/8	40
<b>FIP Union × SWT</b>		600 PSI CWP Max	
3/4"	H-50443W	1/8	38
<b>W/ RESIDENTIAL PRESSURE RELIEF VALVE</b>			
<b>FIP Union × FIP</b>		600 PSI CWP Max	
3/4"	H-40443WPR	1/8	51
<b>FIP Union × SWT</b>		600 PSI CWP Max	
3/4"	H-50443WPR	1/8	51



**E-X-P E2 TANKLESS WATER HEATER SERVICE VALVE KIT**

Hot & Cold Set of Full Port Forged DZR Brass Ball Valves w/ Hi-Flow Hose Drains & Adjustable Packing Glands

**LEAD-FREE BRASS**

Certified to NSF/ANSI 61 & 372

SIZE	ITEM#	CTN/CASE	CASE WT
<b>FIP Union × FIP</b>		500 PSI CWP Max/200°F Max	
3/4"	H-44063W	1/10	34
<b>FIP Union × SWT</b>		500 PSI CWP Max/200°F Max	
3/4"	H-54063W	1/10	35
<b>FIP Union × Press</b>		250 PSI CWP Max/200°F Max	
3/4"	H-84063W	1/10	36
<b>FIP Union × Push</b>		200 PSI CWP Max/200°F Max	
3/4"	H-64063W*	1/10	36
<b>FIP Union × F1960 PEX</b>		400 PSI CWP Max/200°F Max	
3/4"	H-34063W†	1/10	34
<b>FIP Union × F1807 PEX</b>		400 PSI CWP Max/200°F Max	
3/4"	H-14063W†	1/10	33

**W/ PRESSURE RELIEF VALVE OUTLET**

<b>FIP Union × FIP</b>		500 PSI CWP Max	
3/4"	H-44443W	1/10	31
1"	H-44444W	1/10	54
<b>FIP Union × SWT</b>		500 PSI CWP Max	
3/4"	H-54443W	1/10	32
1"	H-54444W	1/10	54
<b>FIP Union × Press</b>		250 PSI CWP Max/250°F Max	
3/4"	H-84443W	1/10	32
1"	H-84444W	1/10	56
<b>FIP Union × Push</b>		200 PSI CWP Max	
3/4"	H-64443W*	1/10	32
<b>FIP Union × F1960 PEX</b>		400 PSI CWP Max	
3/4"	H-34443W†	1/10	34
1"	H-34444W†	1/10	35
<b>FIP Union × F1807 PEX</b>		400 PSI CWP Max	
3/4"	H-14443W†	1/10	33
1"	H-14444W†	1/10	33

**W/ RESIDENTIAL PRESSURE RELIEF VALVE**

<b>FIP Union × FIP</b>		500 PSI CWP Max/210°F Max	
3/4"	H-44443WPR	1/10	37
1"	H-44444WPR	1/10	65
<b>FIP Union × SWT</b>		500 PSI CWP Max/210°F Max	
3/4"	H-54443WPR	1/10	42
1"	H-54444WPR	1/10	65
<b>FIP Union × Press</b>		250 PSI CWP Max/250°F Max	
3/4"	H-84443WPR	1/10	36
1"	H-84444WPR	1/10	65
<b>FIP Union × Push</b>		200 PSI CWP Max/200°F Max	
3/4"	H-64443WPR*	1/10	36
<b>FIP Union × F1960 PEX</b>		400 PSI CWP Max	
3/4"	H-34443WPR†	1/10	38
1"	H-34444WPR†	1/10	40
<b>FIP Union × F1807 PEX</b>		400 PSI CWP Max	
3/4"	H-14443WPR†	1/10	38
1"	H-14444WPR†	1/10	38

**W/ LEAD-FREE RESIDENTIAL PRESSURE RELIEF VALVE**

<b>FIP Union × FIP</b>		500 PSI CWP Max	
3/4"	H-44443WPR-LF	1/10	37
1"	H-44444WPR-LF	1/10	65
<b>FIP Union × SWT</b>		500 PSI CWP Max	
3/4"	H-54443WPR-LF	1/10	42
1"	H-54444WPR-LF	1/10	65
<b>FIP Union × Press</b>		250 PSI CWP Max/250°F Max	
3/4"	H-84443WPR-LF	1/10	36
1"	H-84444WPR-LF	1/10	65
<b>FIP Union × Push</b>		200 PSI CWP Max/200°F Max	
3/4"	H-64443WPR-LF*	1/10	36
<b>FIP Union × F1960 PEX</b>		400 PSI CWP Max/200°F Max	
3/4"	H-34443WPR-LF†	1/10	38
1"	H-34444WPR-LF†	1/10	40
<b>FIP Union × F1807 PEX</b>		400 PSI CWP Max/200°F Max	
3/4"	H-14443WPR-LF†	1/10	38
1"	H-14444WPR-LF†	1/10	38

\*SERVICE VALVES ALSO CERTIFIED TO NSF/ANSI 14, ASSE 1061

†SERVICE VALVES ALSO CERTIFIED TO NSF/ANSI 14



Adjustable PRV outlet ideal for tight spaces

**E-X-P E3 TANKLESS WATER HEATER SERVICE VALVE KIT**

Hot & Cold Set of Full Port Forged Brass Ball Valves w/ Hi-Flow Hose Drains, Adjustable Pressure Relief Valve Outlet & Adjustable Packing Glands - Includes Residential Pressure Relief Valve

**LEAD-FREE BRASS**

Certified to NSF/ANSI 61 & 372

SIZE	ITEM#	CTN/CASE	CASE WT
<b>FIP Union × FIP</b>		500 PSI CWP Max	
3/4"	H-45443WPR	1/10	48
<b>FIP Union × SWT</b>		500 PSI CWP Max	
3/4"	H-55443WPR	1/10	45
<b>FIP Union × Press</b>		250 PSI CWP Max/250°F Max	
3/4"	H-85443WPR	1/10	48
<b>W/ LEVER HANDLES</b>			
<b>FIP Union × FIP</b>		500 PSI CWP Max	
3/4"	H-45443WPR-LH	1/10	48
<b>FIP Union × SWT</b>		500 PSI CWP Max	
3/4"	H-55443WPR-LH	1/10	48
<b>FIP Union × Press</b>		250 PSI CWP Max	
3/4"	H-85443WPR-LH	1/10	48

**PR-LH Kits** include lever handles for tight combi boiler installations





SERVICE VALVE STYLE	E-X-P		E-X-P E2				E-X-P E3		E-X-P Ultra-Compact			E-X-P Union Ball	
<b>Features - all kits include Hot &amp; Cold Set of Full Port Forged Lead-Free Brass Ball Valves</b>													
Pressure Relief Valve (PRV) Outlet	✓	✓	✓	✓	✓	NONE	Adjustable	Adjustable	✓	✓	✓	NONE	
Residential PRV (150 PSI/500,000 BTU/HR)	-	✓	-	✓	Lead Free	-	✓	✓	-	✓	Lead Free	-	
Hose Drains	Hi-Flow	Hi-Flow	Hi-Flow	Hi-Flow	Hi-Flow	Hi-Flow	Hi-Flow	Hi-Flow	✓	✓	✓	-	
Handle Style	Wing	Wing	Wing	Wing	Wing	Wing	Wing	Lever	Compact Lever	Compact Lever	Compact Lever	Wing	
Stem Seals	Adjustable	Adjustable	Adjustable	Adjustable	Adjustable	Adjustable	Adjustable	Adjustable	Double O-Ring	Double O-Ring	Double O-Ring	Adjustable	
Connections	Size	ITEM#	ITEM#	ITEM#	ITEM#	ITEM#	ITEM#	ITEM#	ITEM#	ITEM#	ITEM#	ITEM#	
FIP Union × FIP	3/4"	H-40443W	H-40443WPR	H-44443W	H-44443WPR	H-44443WPR-LF	H-44063W	H-45443WPR	H-45443WPR-LH	H-42443W	H-42443WPR	H-42443WPR-LF	H-40423W-RB
	1"	-	-	H-44444W	H-44444WPR	H-44444WPR-LF	-	-	-	-	-	-	-
FIP Union × SWT	3/4"	H-50443W	H-50443WPR	H-54443W	H-54443WPR	H-54443WPR-LF	H-54063W	H-55443WPR	H-55443WPR-LH	H-52443W	H-52443WPR	H-52443WPR-LF	H-50423W-RB
	1"	-	-	H-54444W	H-54444WPR	H-54444WPR-LF	-	-	-	-	-	-	-
FIP Union × Press	3/4"	-	-	H-84443W	H-84443WPR	H-84443WPR-LF	H-84063W	H-85443WPR	H-85443WPR-LH	-	-	-	H-80423W-RB
	1"	-	-	H-84444W	H-84444WPR	H-84444WPR-LF	-	-	-	-	-	-	-
FIP Union × Push	3/4"	-	-	H-64443W	H-64443WPR	H-64443WPR-LF	H-64063W	-	-	-	-	-	-
	1"	-	-	H-64444W	H-64444WPR	H-64444WPR-LF	-	-	-	-	-	-	-
FIP Union × F1960 PEX	3/4"	-	-	H-34443W	H-34443WPR	H-34443WPR-LF	H-34063W	-	-	-	-	-	H-30423W-RB
	1"	-	-	H-34444W	H-34444WPR	H-34444WPR-LF	-	-	-	-	-	-	-
FIP Union × F1807 PEX	3/4"	-	-	H-14443W	H-14443WPR	H-14443WPR-LF	H-14063W	-	-	-	-	-	H-10423W-RB
	1"	-	-	H-14444W	H-14444WPR	H-14444WPR-LF	-	-	-	-	-	-	-

TWH SERVICE VALVES  
**E·X·P**  
ULTRA-COMPACT

**COMPACT DESIGN**

Installs in 30% less space than the E-X-P E2

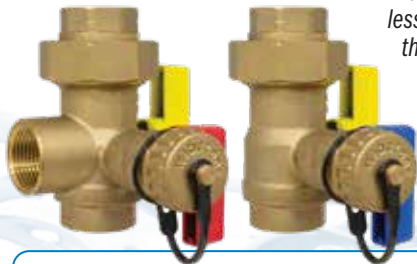

TWH SERVICE VALVES  
**E·X·P**  
UNION BALL

For appliances with integrated PRV & drain ports



**E-X-P ULTRA-COMPACT TANKLESS WATER HEATER SERVICE VALVE KIT**

Hot & Cold Set of Full Port Forged DZR Brass Ball Valves w/ 3/4" Hose Drains & Pressure Relief Valve Outlet

**LEAD-FREE BRASS**

Certified to NSF/ANSI 61 & 372

SIZE	ITEM#	CTN/CASE	CASE WT
FIP Union × FIP		250 PSI CWP Max/200°F Max	
3/4"	H-42443W	1/12	40
FIP Union × SWT		250 PSI CWP Max/200°F Max	
3/4"	H-52443W	1/12	39

**INCLUDES RESIDENTIAL PRESSURE RELIEF VALVE (150 PSI/500,000 BTU/HR)**

FIP Union × FIP		250 PSI CWP Max/200°F Max	
3/4"	H-42443WPR	1/12	45
FIP Union × SWT		250 PSI CWP Max/200°F Max	
3/4"	H-52443WPR	1/12	45

**INCLUDES LEAD-FREE PRESSURE RELIEF VALVE (150 PSI/500,000 BTU/HR)**

FIP Union × FIP		250 PSI CWP Max/200°F Max	
3/4"	H-42443WPR-LF	1/12	45
FIP Union × SWT		250 PSI CWP Max/200°F Max	
3/4"	H-52443WPR-LF	1/12	45

**E-X-P UNION BALL TANKLESS WATER HEATER SERVICE VALVE KIT**

Hot & Cold Set of Full Port Forged DZR Brass Ball Valves w/ Union Ends & Adjustable Packing Glands,

**LEAD-FREE BRASS**

Certified to NSF/ANSI 61 & 372

SIZE	ITEM#	CTN/CASE	CASE WT
FIP Union × FIP		250 PSI CWP Max/200°F Max	
3/4"	H-40423W-RB	1/12	31
FIP Union × SWT		250 PSI CWP Max/200°F Max	
3/4"	H-50423W-RB	1/12	30
FIP Union × Press		250 PSI CWP Max/200°F Max	
3/4"	H-80423W-RB	1/12	32
FIP Union × F1960 PEX		250 PSI CWP Max/200°F Max	
3/4"	H-30423W-RB*	1/12	30
FIP Union × F1807 PEX		250 PSI CWP Max/200°F Max	
3/4"	H-10423W-RB*	1/12	30

\*ALSO CERTIFIED TO NSF/ANSI 14



Also perfect for traditional tanked water heater connections

**E-X-P ACCESSORIES**



**E-X-P PRESSURE RELIEF VALVE RELOCATION ADAPTER**  
For Recessed Boxes, Tight or Unique Installations

**LEAD-FREE BRASS**  
Certified to NSF/ANSI 61 & 372

SIZE	ITEM#	CTN/CASE	CASE WT
Fits E-X-P E2			
3/4"	H-28023W	10/100	58



**PRESSURE RELIEF VALVES**

**STANDARD BRASS**

SIZE	ITEM#	CTN/CASE	CASE WT
<b>RESIDENTIAL PRESSURE RELIEF VALVE</b>			
150 PSI CWP Max/500,000 BTU/HR			
3/4"	H-20713*	1/100	46
<b>COMMERCIAL GRADE PRESSURE RELIEF VALVE &amp; CLOSE NIPPLE</b>			
150 PSI CWP Max/2.7M BTU			
3/4"	H-20723-CN†	1/10	15
<b>BOILER PRESSURE RELIEF VALVE</b>			
30 PSI CWP Max/510,000 BTU/HR			
3/4"	H-20733‡	1/100	46

**LEAD-FREE BRASS**

SIZE	ITEM#	CTN/CASE	CASE WT
<b>RESIDENTIAL PRESSURE RELIEF VALVE</b>			
150 PSI CWP Max/500,000 BTU/HR			
3/4"	H-20713W*	1/100	46

CERTIFICATION APPLIES TO CASH ACME \*FWL-2, †F-82, ‡F-30

# TWH SERVICE VALVES E·X·P<sup>®</sup> COMPLETE

PATENTED TECHNOLOGY WITH  
FURTHER PATENTS PENDING

- Kits include your choice of TWH service valves with pressure relief valve, integrated gas sediment trap, gas ball valve, and gas flex line
- Results in cleaner looking, consistent quality, more professional installations
- Saves labor and eliminates repetitive field fabrication
- Reduces leak paths

## E-X-P COMPLETE TANKLESS WATER HEATER INSTALLATION KIT

Includes E-X-P E2 Service Valves w/ Residential Pressure Relief Valve (150 PSI/500,000 BTU/HR) & 3/4" FIP Full Port Forged Brass Gas Sediment Trap w/ 3/4" FIP Gas Ball Valve & 24" Flex Line

### LEAD-FREE BRASS

TWH SERVICE VALVES: Certified to NSF/ANSI 61 & 372

GAS COMPONENTS: Flex Line: ANSI Z21.24 & CSA 6.10  
- Valve: ANSI Z21.15 & CSA 9.1

SIZE	ITEM#	CTN/CASE	CASE WT
FIP Union x FIP		500 PSI CWP Max/210°F Max*	
3/4"	H-44443WPR-GST	1/4	29
FIP Union x SWT		500 PSI CWP Max/210°F Max*	
3/4"	H-54443WPR-GST	1/4	30
FIP Union x Press		250 PSI CWP Max/250°F Max*	
3/4"	H-84443WPR-GST	1/4	28
FIP Union x Push		200 PSI CWP Max/200°F Max*	
3/4"	H-64443WPR-GST	1/4	28
FIP Union x F1960 PEX		400 PSI CWP Max/200°F Max*	
3/4"	H-34443WPR-GST	1/4	29
FIP Union x F1807 PEX		400 PSI CWP Max/200°F Max*	
3/4"	H-14443WPR-GST	1/4	29

\*GAS COMPONENTS RATED AT 1/2 PSI MAX/149°F MAX

†TWH SERVICE VALVES ALSO CERTIFIED TO NSF/ANSI 14, ASSE 1061

‡TWH SERVICE VALVES ALSO CERTIFIED TO NSF/ANSI 14

## TWH SERVICE VALVES E·X·P E2 SPACE SAVING



## TWH SERVICE VALVES E·X·P ULTRA-COMPACT



## E-X-P COMPLETE TANKLESS WATER HEATER INSTALLATION KIT

Includes E-X-P Ultra Compact Service Valves w/ Residential Pressure Relief Valve (150 PSI/500,000 BTU/HR) & 3/4" FIP Full Port Forged Brass Gas Sediment Trap w/ 3/4" FIP Gas Ball Valve & 24" Flex Line

### LEAD-FREE BRASS

TWH SERVICE VALVES: Certified to NSF/ANSI 61 & 372

GAS COMPONENTS: Flex Line: ANSI Z21.24 & CSA 6.10  
- Valve: ANSI Z21.15 & CSA 9.1

SIZE	ITEM#	CTN/CASE	CASE WT
FIP Union x FIP		250 PSI CWP Max/200°F Max*	
3/4"	H-42443WPR-GST	1/4	26
FIP Union x SWT		250 PSI CWP Max/200°F Max*	
3/4"	H-52443WPR-GST	1/4	26

\*GAS COMPONENTS RATED AT 1/2 PSI MAX/149°F MAX



# GAS SEDIMENT TRAP

## THE **CLEANEST** WAY TO INSTALL **GAS** APPLIANCES

PATENTS PENDING

- 1/2" & 3/4" sizes cover most installation needs
- Includes full port gas ball valve
- Available w/ 24" gas flex line
- Results in cleaner looking, consistent quality, more professional installations
- Eliminates repetitive field fabrication
- Saves labor
- Reduces leak paths



### GAS SEDIMENT TRAP KIT 3" Tee Fitting & Cap

#### STANDARD BRASS

Flex Line: ANSI Z21.24 & CSA 6.10  
- Valve: ANSI Z21.15 & CSA 9.1

SIZE FIP	ITEM#	CTN/CASE	CASE WT
		1/2 PSI Max/149°F Max	
<b>W/ FULL PORT FORGED BRASS GAS BALL VALVE &amp; 24" GAS FLEX LINE</b>			
1/2"	H-22442-24-FP	1/10	29
3/4"	H-22443-24-FP	1/10	34
<b>W/ FULL PORT FORGED BRASS GAS BALL VALVE</b>			
1/2"	H-22442	1/20	26
3/4"	H-22443	1/20	38

## FLEXIBLE DESIGN MAXIMIZES VERSATILITY

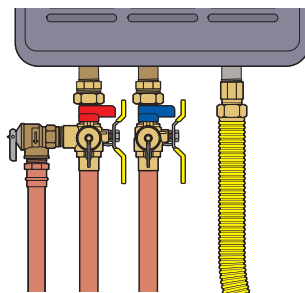

Connect  
flex hose  
to the  
appliance

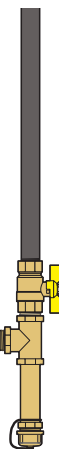

Connect  
flex hose  
to the  
supply line

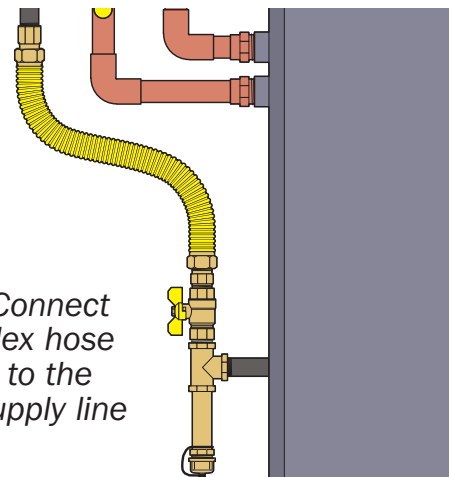

# UNDER BOILER SOLUTIONS

## A **SINGLE SOURCE** FOR BETTER **INSTALLATIONS**

- Saves time, space, and labor
- Maintains system efficiency
- Simplifies future maintenance
- Full-featured installations require no more than 22"
- Innovative solutions available for external pumps and combi DHW connections
- G-Union accessories for unique installation needs - see page 25

### **AIR SEPARATOR**

*Reduces noise and improves system operation - SEE PAGE 20*

### **MAGNETIC BOILER FILTER**

*High-powered magnet captures ferrous debris - SEE PAGE 22*

### **HYDRO-CORE MANIFOLD**

*Avoids precise calculations and costly field fabrication - SEE PAGE 17*

### **DIFFERENTIAL PRESSURE BY-PASS VALVE**

*Eliminates noise in a zoned hydronic system with fixed-speed primary circulator pump - SEE PAGE 24*

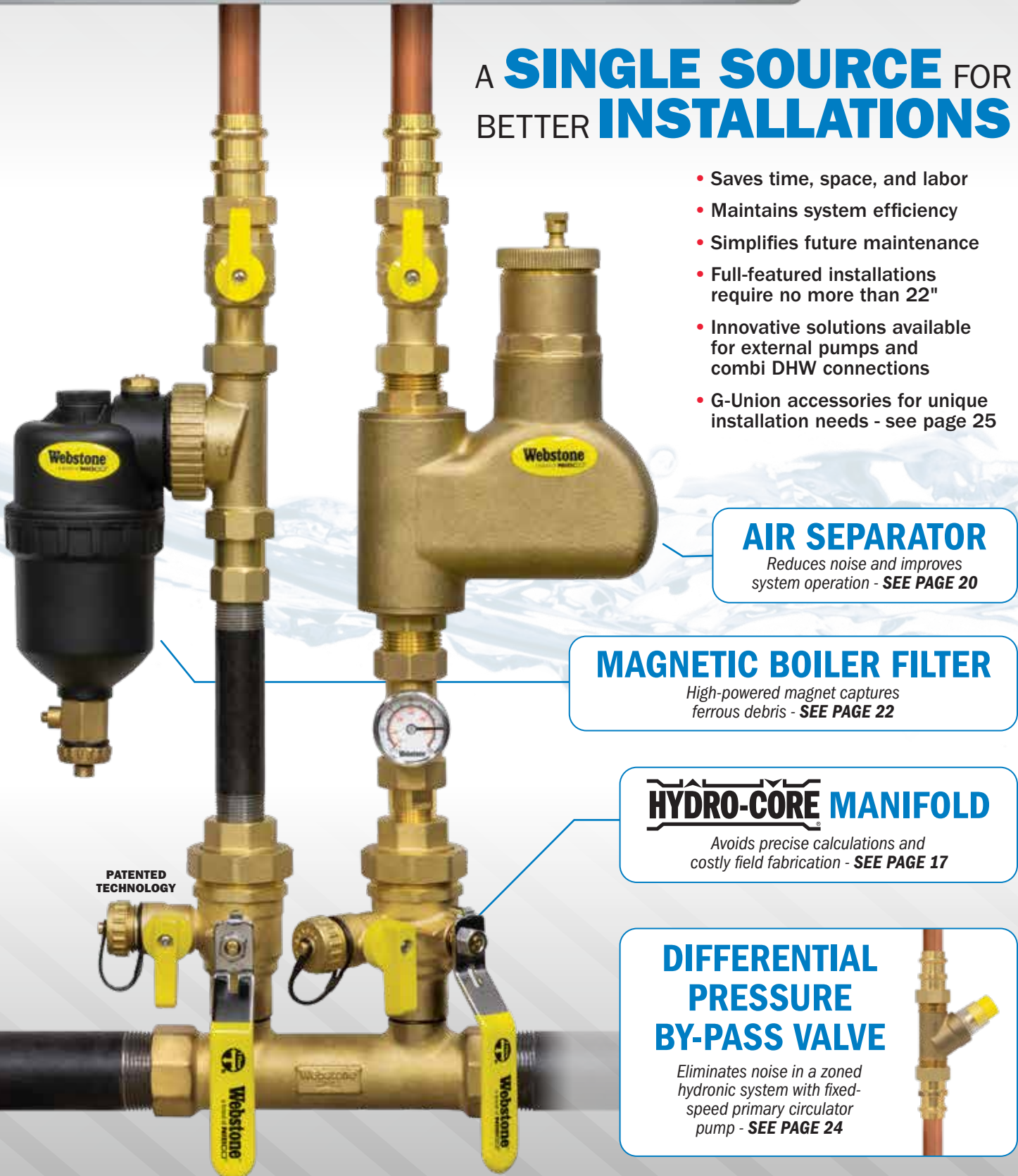

**PATENTED TECHNOLOGY**



# HYDRO-CORE®

PATENTED TECHNOLOGY

THE **CORE** OF ANY PROFESSIONAL **HYDRONIC** INSTALLATION

The Hydro-Core Manifold is the ideal solution for most near boiler piping or secondary loops.

- Eliminates costly field fabrication
- Avoids precise calculations
- Simplifies future maintenance
- Saves space
- All with EXPERT looking results

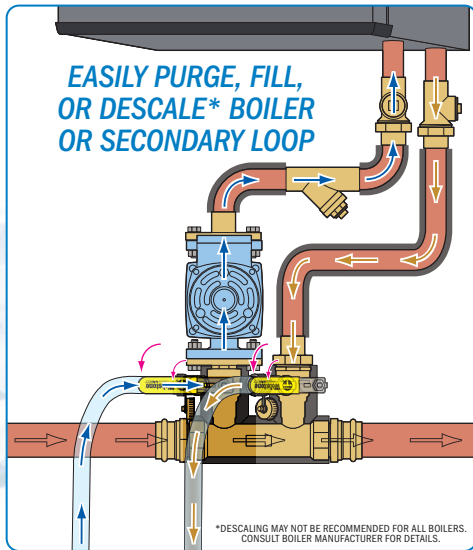

## MANIFOLD DESIGNS

Double Ball Drain



Flange Right



Flange Left



## HYDRO-CORE UNION CONNECTION

Available in three distinct styles  
SEE PAGE 19

Three Manifold Designs  
Choice of union or flange connections to accommodate internal of external pumps

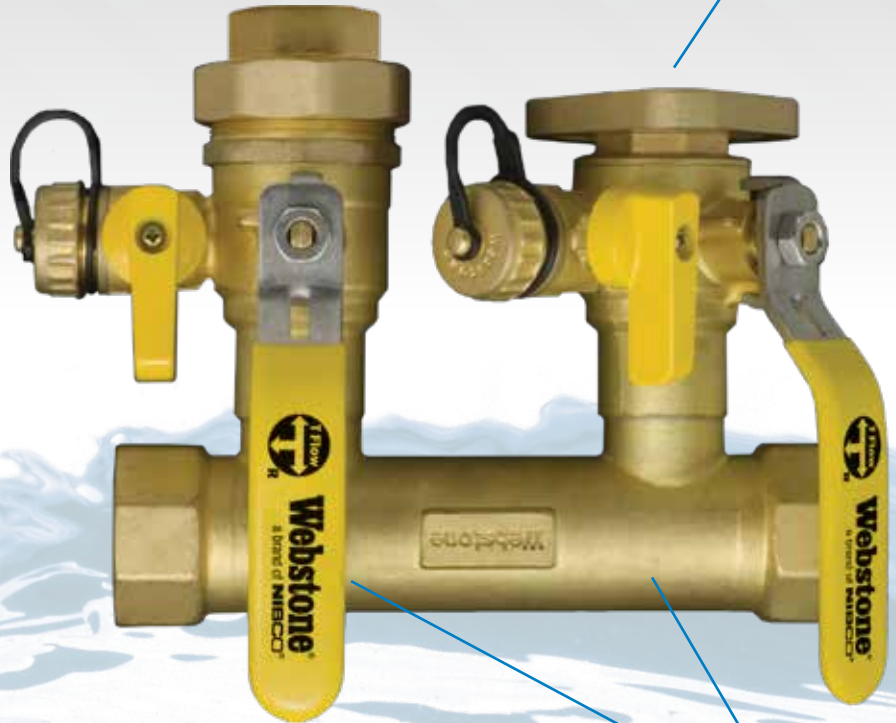

**T-Flow Ball**

Directs flow into either the boiler or purge drain

**Precision-Crafted Closely Spaced Tees**  
For hydraulic separation

**Fully-Insulated Body**



**Snug-Fit Rotating Flange**  
Provides greater control during installation



## HYDRO-CORE MANIFOLD KITS

Kits include Manifold and Union Connections

Manifold Design	System Run	Boiler Connection	FIP	SWT	Press × FIP
Double Ball Drain	1 1/4"	3/4"	H-48354-43	H-58354-53	H-88354-43
	1 1/4"	1"	H-48354-44	H-58354-54	H-88354-44
Flange Right	1 1/4"	3/4"	H-48754-43	H-58754-53	H-88754-43
	1 1/4"	1"	H-48754-44	H-58754-54	H-88754-44
	1 1/2"	1 1/4"	H-48765-45	H-58765-55	H-88765-45
Flange Left	1 1/4"	3/4"	H-48854-43	H-58854-53	H-88854-43
	1 1/4"	1"	H-48854-44	H-58854-54	H-88854-44
	1 1/2"	1 1/4"	H-48865-45	H-58865-55	H-88865-45

### BOILER COMPATIBILITY ASSUMPTIONS:

- Hydro-Core manifolds will be selected in accordance with the manufacturers' recommended run, supply and return sizes.
- Selected heat flow direction is acceptable for the installation.
- Customers will ensure that their installation can accommodate any other devices noted by the boiler manufacturer.
- External pumps will be mounted to the manifold and connected to the boiler return.

### THE OLD WAY

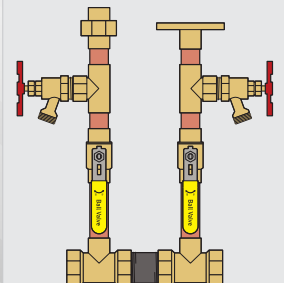

### THE WEBSTONE WAY

REPLACES **17** COMPONENTS  
SAVES **144** MINUTES  
ELIMINATES **16** LEAK PATHS

# HYDRO-CORE

## COMPLETE NEAR BOILER PIPING KITS

A fully-fabricated solution, kits include everything necessary for a successful installation.

REPLACES **34** COMPONENTS  
 SAVES **261** MINUTES  
 ELIMINATES **29** LEAK PATHS  
*(Savings vary by kit)*

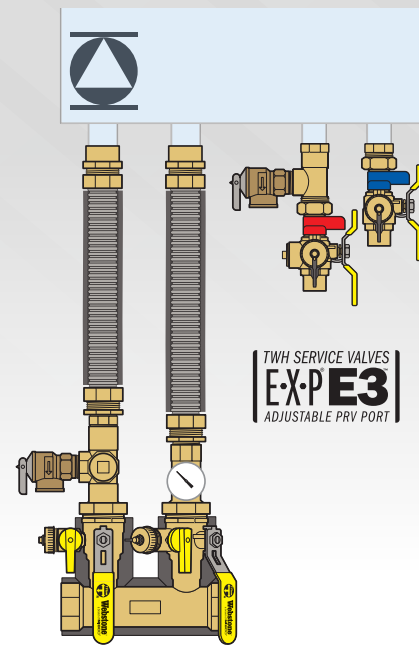
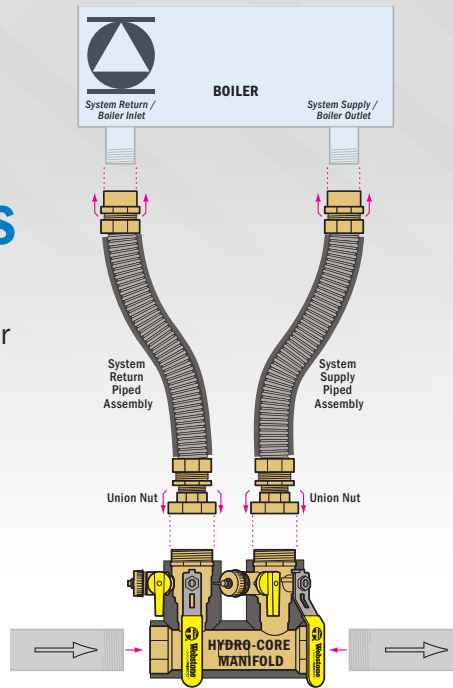

## COMBI BOILER KITS†

Includes all the features of the wall hung boiler kits, plus components for DHW connections

## WALL HUNG BOILER KITS†

- Choice of Press, FIP or SWT Hydro-Core Double Ball Drain Manifold
- Insulated manifold, supply & return lines
- Integrated connections for your specific boiler
- Assembled with flexible stainless steel tubing
- Tubing may be cut for installations in close quarters

- Plugged FIP ports for connection to other devices
- 1/4" pressure gauge port
- 30 psi pressure gauge
- 30 psi pressure relief valve for boiler
- 3/4" E-X-P E3 service valve kit
- 150 psi pressure relief valve for DHW

† Features vary by kit.

## FIND THE RIGHT KIT FOR YOUR BOILER:

SEE [WWW.WEBSTONEVALVES.COM/HYDROCORE](http://WWW.WEBSTONEVALVES.COM/HYDROCORE) FOR A FULL BOILER COMPATIBILITY CHART

### Complete Near Boiler Piping Kits

SYSTEM PIPING	ITEM#	ITEM#	ITEM#	ITEM#
FIP	H-4CC4-NBHK	H-4FK4-WIF	H-4CCL54-54Y	H-4FK5-CH
SWT	H-5CC4-NBHK	H-5FK4-WIF	H-5CCL54-54Y	H-5FK5-CH
PRESS	H-8CC4-NBHK	H-8FK4-WIF	H-8CCL54-54Y	H-8FK5-CH
Kit Features				
SYSTEM RUN	1 1/4"	1 1/4"	1 1/4"	1 1/4"
BOILER CONNECTION	1"	1"	1"	1"
MANIFOLD TYPE	Double Ball Drain	Double Ball Drain	Flange Left	Double Ball Drain
SUPPLY & RETURN PIPING	Bent Copper	Flexible Stainless Steel (Two 12" Lengths)	Bent Copper	Flexible Stainless Steel (10.5" & 12" Lengths)
FULLY INSULATED	✓	✓	✓	✓
1/4" NPT GAUGE PORT	-	-	-	✓
PRESSURE GAUGE	-	-	-	✓
3/4" FIP DEVICE PORTS	-	-	✓	✓
MESH "Y" STRAINER	-	-	✓	-
30 PSI BOILER PRV	-	-	-	✓
3/4" E-X-P E3 DHW SERVICE VALVES	-	-	-	✓
150 PSI DHW PRV	-	-	-	Lead-Free

# HYDRO-CORE

## UNION CONNECTIONS

Join mixed piping types, add a gauge, or connect devices to your Hydro-Core installation.

Manifold / Union Connection Compatibility			
UNION CONNECTION SIZE	FIP MANIFOLD KIT	SWT MANIFOLD KIT	PRESS MANIFOLD KIT
1"	H-48354-43	H-58354-53	H-88354-43
1"	H-48354-44	H-58354-54	H-88354-44
1"	H-48754-43	H-58754-53	H-88754-43
1"	H-48754-44	H-58754-54	H-88754-44
1 1/4"	H-48765-45	H-58765-55	H-88765-45
1"	H-48854-43	H-58854-53	H-88854-43
1"	H-48854-44	H-58854-54	H-88854-44
1 1/4"	H-48865-45	H-58865-55	H-88865-45

### HYDRO-CORE UNION CONNECTION

STANDARD BRASS			
SIZE	ITEM#	CTN/CASE	CASE WT
<b>1" UNION CONNECTION</b>			
FIP		600 PSI CWP Max	
3/4"	H-HCE4-43	6/24	14
1"	H-HCE4-44	6/24	11
<b>SWT</b>			
3/4"	H-HCE4-53	6/24	12
1"	H-HCE4-54	6/24	12
<b>1 1/4" UNION CONNECTION</b>			
FIP		600 PSI CWP Max	
1"	H-HCE5-44	6/24	20
1 1/4"	H-HCE5-45	6/24	16
<b>SWT</b>			
1"	H-HCE5-54	6/24	17
1 1/4"	H-HCE5-55	6/24	18



### HYDRO-CORE UNION CONNECTION

w/ 1/4" NPT Gauge Port (Plugged)

STANDARD BRASS			
SIZE	ITEM#	CTN/CASE	CASE WT
<b>1" UNION CONNECTION</b>			
FIP		600 PSI CWP Max	
3/4"	H-HCE4-63	6/24	25
1"	H-HCE4-64	6/24	22
<b>SWT</b>			
3/4"	H-HCE4-73	6/24	19
1"	H-HCE4-74	6/24	19
<b>1 1/4" UNION CONNECTION</b>			
FIP		600 PSI CWP Max	
1"	H-HCE5-64	6/24	37
1 1/4"	H-HCE5-65	6/24	38
<b>SWT</b>			
1"	H-HCE5-74	6/24	27
1 1/4"	H-HCE5-75	6/24	27



### HYDRO-CORE UNION CONNECTION

w/ Multiple Device Ports · Plugged Connections for (2) 3/4" Devices or (1) 3/4" Device & (1) 1/4" Pressure Gauge

STANDARD BRASS			
SIZE	ITEM#	CTN/CASE	CASE WT
<b>1" UNION CONNECTION</b>			
SWT		600 PSI CWP Max	
1"	H-HCE4-94	6/24	27

## BOILER SERVICE VALVES E·X·P SERIES

## WALL HUNG & COMBI BOILER INSTALLATIONS

### WALL HUNG & COMBI BOILER SERVICE VALVE KIT

Hot & Cold Set of Full Port Forged Brass Ball Valves w/ Hi-Flow Hose Drains, Pressure Relief Valve Outlet & Adjustable Packing Glands

STANDARD BRASS				
SIZE	ITEM#	PR3 ITEM#	CTN/CASE	CASE WT
<b>FIP Union × FIP</b>				
1"	H-44444	H-44444PR3	500 PSI CWP Max	1/10 54
<b>LEAD-FREE BRASS</b>				
Certified to NSF/ANSI 61 & 372				
SIZE	ITEM#	PR3 ITEM#	CTN/CASE	CASE WT
<b>FIP Union × FIP</b>				
1"	H-44444W	H-44444WPR3	500 PSI CWP Max	1/10 54
<b>FIP Union × SWT</b>				
1"	H-54444W	H-54444WPR3	500 PSI CWP Max	1/10 54
<b>FIP Union × Press</b>				
1"	H-84444W	H-84444WPR3	250 PSI CWP Max/250°F Max	1/10 56

Save space, simplify maintenance, and eliminate leak paths utilizing an E-X-P kit for wall hung or combi boiler hydronic heat connections.

E-X-P TANKLESS WATER HEATER KITS ARE IDEAL FOR COMBI BOILER DHW CONNECTIONS - **SEE PAGE 10**

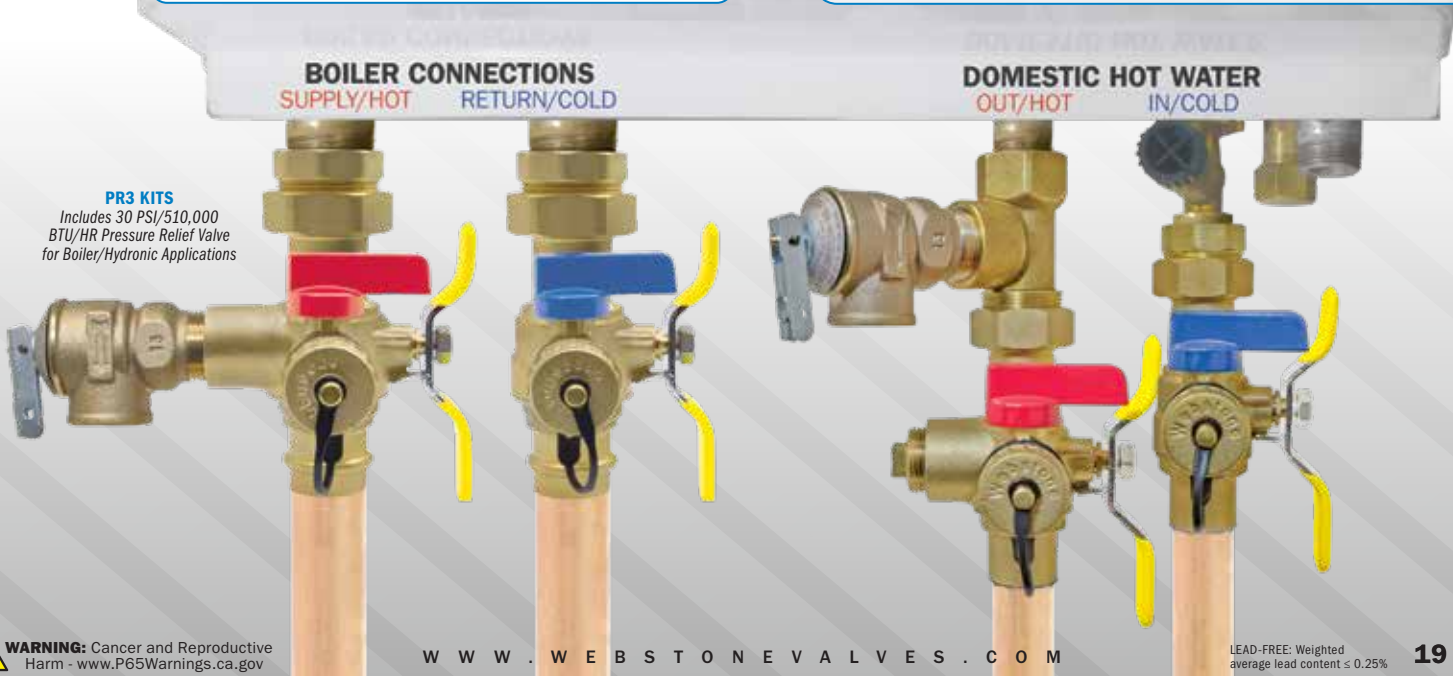

**PR3 KITS**  
Includes 30 PSI/510,000 BTU/HR Pressure Relief Valve for Boiler/Hydronic Applications



# VERTICAL AIR SEPARATOR

## KNOCKING PIPES ARE NOT NORMAL

- Reduces noise
- Improves system efficiency and operation
- Reduces wear on system components
- Vertical or horizontal mount options
- Flow may be directed into either side of the unit
- Wide range of G-Union Accessories offer a solution for most installation needs - see page 25

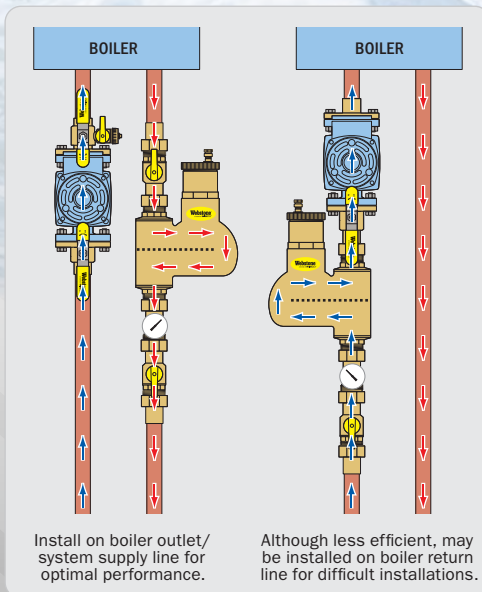
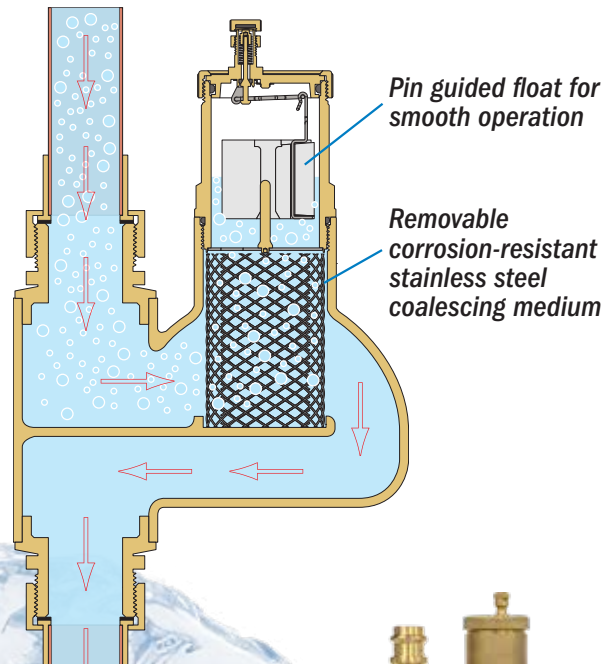

### BRASS AIR SEPARATOR

w/ Removable Vent Head & Coalescing Medium - For Vertical Installations

STANDARD BRASS			
SIZE	ITEM#	CTN/CASE	CASE WT
<b>FIP</b>			
3/4"	H-74003-V	150 PSI CWP Max/250°F Max	47
1"	H-74004-V		48
<b>MIP</b>			
3/4"	H-72003-V	1/8	45
1"	H-72004-V	1/8	47
<b>SWT</b>			
3/4"	H-75003-V	1/8	45
1"	H-75004-V	1/8	46
<b>Press</b>			
3/4"	H-78003-V	1/8	47
1"	H-78004-V	1/8	47
<b>BODY ONLY - INSTALL W/ (2) G-UNION FITTINGS</b>			
<b>G-Thread</b>			
1"	H-71000-V	1/8	41



# HORIZONTAL AIR SEPARATOR



- Horizontal model includes FIP expansion tank connection

**BRASS AIR SEPARATOR**  
w/ Removable Vent Head & Coalescing Medium

STANDARD BRASS			
SIZE	ITEM#	CTN/CASE	CASE WT
150 PSI CWP Max/250°F Max			
FIP			
3/4"	H-74003	1/10	25
1"	H-74004	1/10	27
1 1/4"	H-74005	1/10	27
1 1/2"	H-74006	1/10	63
2"	H-74007	1/10	67
SWT			
3/4"	H-75003	1/10	25
1"	H-75004	1/10	25
1 1/4"	H-75005	1/10	25
1 1/2"	H-75006	1/10	65
2"	H-75007	1/10	65
Press			
3/4"	H-78003	1/10	30
1"	H-78004	1/10	32
1 1/4"	H-78005	1/10	36
1 1/2"	H-78006	1/10	76
2"	H-78007	1/10	85



- Replacement vent assembly compatible with vertical and horizontal air separator

**REPLACEMENT VENT ASSEMBLY**

SIZE	ITEM#	CTN/CASE	CASE WT
FITS 3/4"-2" AIR SEPARATOR	H-74000	1/50	13

IDEAL FOR USE WITH



SEE PAGE 35

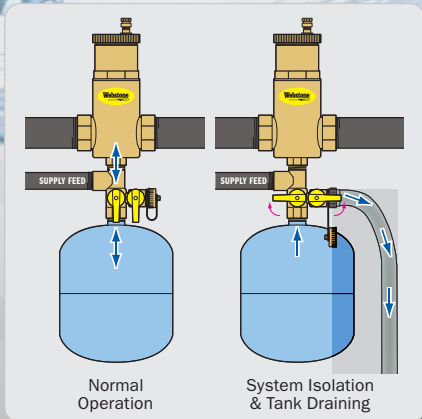

# MAGNETIC BOILER FILTER

THE **POWERFUL** WAY  
TO STAY **EFFICIENT**



- High-powered 12,000 Gauss magnet captures ferrous debris
- Mess-free clean out - remove magnet from sleeve and debris falls into cavity below
- Universal diverter allows use with any piping orientation
- G-Union connections with or without available isolation valves
- Includes service tool
- Protects system components
- Maintains system efficiency
- Wide range of G-Union Accessories offer a solution for most installation needs - see page 25

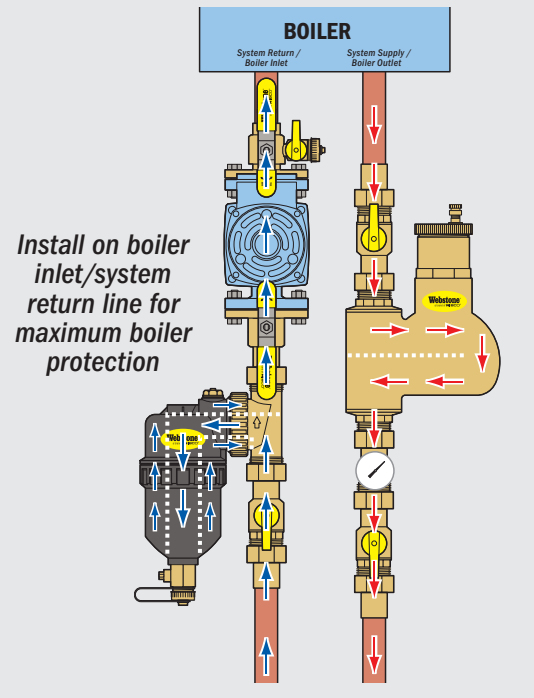
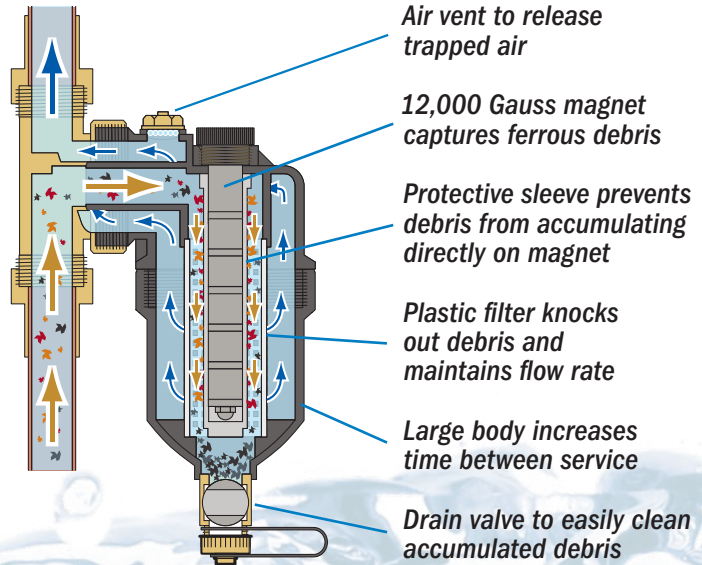

## MAGNETIC BOILER FILTER

12,000 Gauss Magnet, Diverter, Integrated Hose Drain Valve, Air Vent & Filter Includes (2) Union End Connections & Service Tool

SIZE	ITEM#	STANDARD BRASS	
		CTN/CASE	CASE WT
<b>FIP</b>			
3/4"	H-74703	175 PSI CWP Max/250°F Max	11
1"	H-74704	1/4	11
<b>MIP</b>			
3/4"	H-72703	1/4	11
1"	H-72704	1/4	11
<b>SWT</b>			
3/4"	H-75703	1/4	11
1"	H-75704	1/4	11
<b>Press</b>			
3/4"	H-78703	1/4	11
1"	H-78704	1/4	11

## W/ (2) G-UNION ISOLATION VALVES

SIZE	ITEM#	STANDARD BRASS	
		CTN/CASE	CASE WT
<b>FIP</b>			
3/4"	H-74713	175 PSI CWP Max/250°F Max	11
1"	H-74714	1/4	11
<b>MIP</b>			
3/4"	H-72713	1/4	11
1"	H-72714	1/4	11
<b>SWT</b>			
3/4"	H-75713	1/4	11
1"	H-75714	1/4	11
<b>Press</b>			
3/4"	H-78713	1/4	11
1"	H-78714	1/4	11

## BODY ONLY - INSTALL W/ (2) G-UNION FITTINGS

SIZE	ITEM#	CTN/CASE	CASE WT
G-Thread			
1"	H-70700	1/4	11





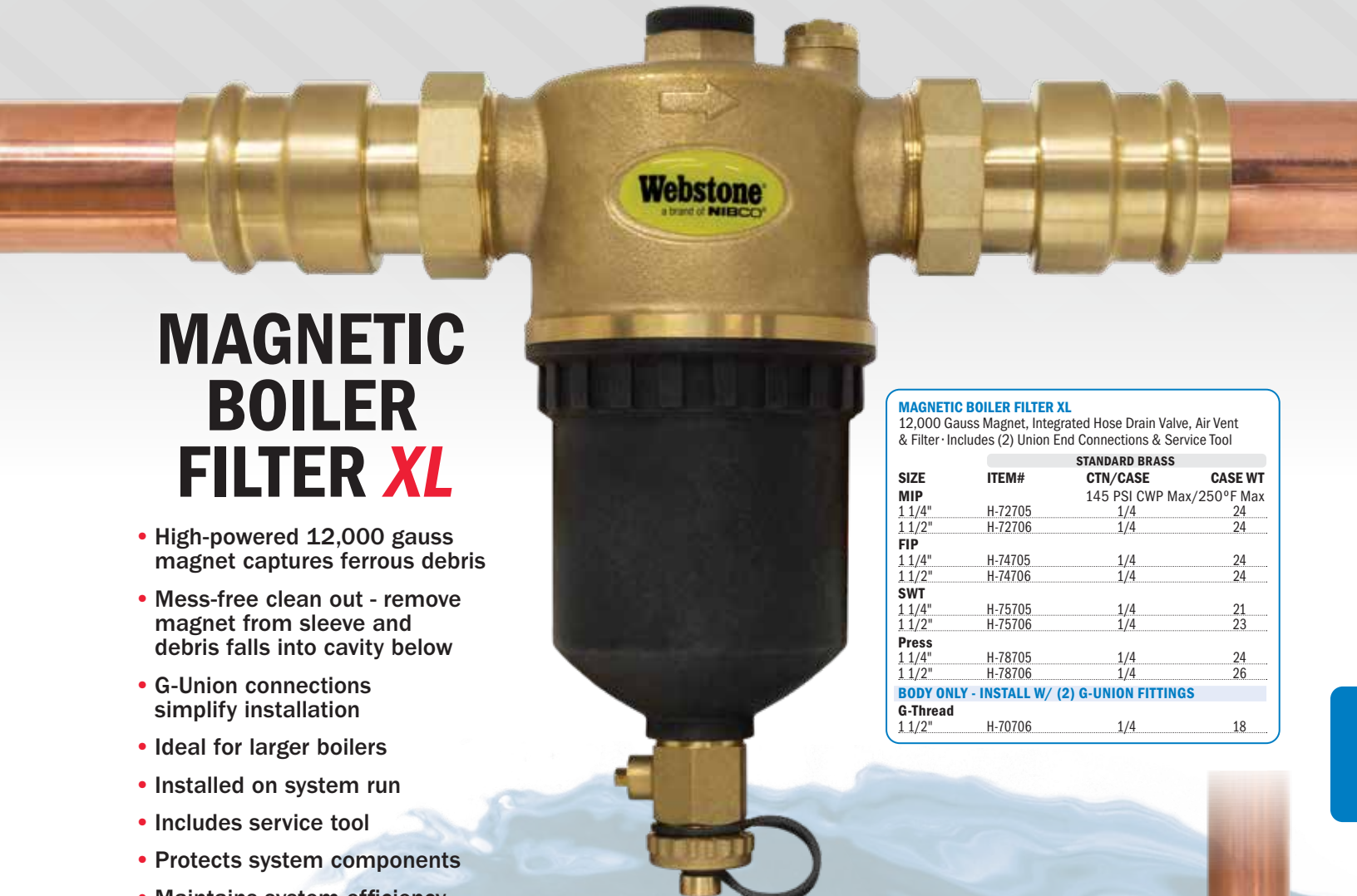

# MAGNETIC BOILER FILTER XL

- High-powered 12,000 gauss magnet captures ferrous debris
- Mess-free clean out - remove magnet from sleeve and debris falls into cavity below
- G-Union connections simplify installation
- Ideal for larger boilers
- Installed on system run
- Includes service tool
- Protects system components
- Maintains system efficiency

### MAGNETIC BOILER FILTER XL

12,000 Gauss Magnet, Integrated Hose Drain Valve, Air Vent & Filter - Includes (2) Union End Connections & Service Tool

SIZE	ITEM#	STANDARD BRASS	
		CTN/CASE	CASE WT
MIP		145 PSI CWP Max/250°F Max	
1 1/4"	H-72705	1/4	24
1 1/2"	H-72706	1/4	24
FIP			
1 1/4"	H-74705	1/4	24
1 1/2"	H-74706	1/4	24
SWT			
1 1/4"	H-75705	1/4	21
1 1/2"	H-75706	1/4	23
Press			
1 1/4"	H-78705	1/4	24
1 1/2"	H-78706	1/4	26
<b>BODY ONLY - INSTALL W/ (2) G-UNION FITTINGS</b>			
G-Thread			
1 1/2"	H-70706	1/4	18

# Y-STRAINERS



- Connect a Y-strainer directly to any standard circulator pump
- Rotating flange provides versatility
- 1/2" plugged NPT strainer port for installation of drain valve

- Replaceable 20 mesh screen
- O-ring sealed and plugged strainer port for easy removal of filter and installation of drain valve
- Suitable for vertical or horizontal installation

### Y-STRAINER W/ROTATING FLANGE

SIZE	ITEM#	STANDARD BRASS	
		CTN/CASE	CASE WT
SWT x Rotating Flange		600 PSI CWP Max	
1"	H-FSTR4-54	6/24	39
1 1/4"	H-FSTR5-55	6/24	47

### FORGED DZR BRASS Y-STRAINER (20 MESH)

w/ 1/2" Plugged NPT Port

SIZE	ITEM#	LEAD-FREE BRASS	
		CTN/CASE	CASE WT
FIP		250 PSI CWP Max/200°F Max	
1/2"	H-40562W	8/80	40
3/4"	H-40563W	6/60	42
1"	H-40564W	4/40	35
1 1/4"	H-40565W	4/24	35
1 1/2"	H-40566W	2/20	41
2"	H-40567W	2/10	34
Press		250 PSI CWP Max/200°F Max	
1/2"	H-80562W	12/72	40
3/4"	H-80563W	6/48	38
1"	H-80564W	5/40	38
1 1/4"	H-80565W	4/24	34
1 1/2"	H-80566W	2/12	28
2"	H-80567W	2/8	29

**BALL DRAIN**  
STRAINER™  
INCLUDES INTEGRATED  
Y-STRAINER  
SEE PAGE 29





# DIFFERENTIAL PRESSURE BY-PASS VALVE

THE **QUIET** WAY TO ZONE **FIXED-SPEED** SYSTEMS

- Eliminates noise in a zoned hydronic system with fixed-speed primary circulator pump
- Protects system components
- Maintains system efficiency
- Prevents over-pumping of zones
- Installs between the boiler supply and return lines, or between zone legs in larger systems
- Installs in any orientation
- Customize with G-Union Accessories

## FORGED BRASS DIFFERENTIAL PRESSURE BY-PASS VALVE

Opening Differential Pressure Setting  
Adjustable from 1.5 to 9 PSI

SIZE	MAX GPM	STANDARD BRASS		
		ITEM#	CTN/CASE	CASE WT
<b>FIP</b>				
145 PSI CWP Max/230°F Max				
3/4"	9	H-74533	1/36	25
1"	18	H-74544	1/36	31
<b>MIP</b>				
3/4"	9	H-72533	1/36	25
1"	18	H-72544	1/36	31
<b>SWT</b>				
3/4"	9	H-75533	1/36	25
1"	18	H-75544	1/36	31
<b>Press</b>				
3/4"	9	H-78533	1/36	25
1"	18	H-78544	1/36	31
<b>BODY ONLY - INSTALL W/(2) G-UNION FITTINGS</b>				
<b>G-Thread</b>				
1"	9	H-70530	1/36	25
1"	18	H-70540	1/36	31

## FORGED BRASS ANGLED DIFFERENTIAL PRESSURE BY-PASS VALVE

Opening Differential Pressure Setting  
Adjustable from 1.5 to 9 PSI

SIZE	MAX GPM	STANDARD BRASS		
		ITEM#	CTN/CASE	CASE WT
<b>FIP</b>				
145 PSI CWP Max/230°F Max				
3/4"	9	H-74533-A	1/36	22
1"	18	H-74544-A	1/36	28
<b>MIP</b>				
3/4"	9	H-72533-A	1/36	22
1"	18	H-72544-A	1/36	28
<b>SWT</b>				
3/4"	9	H-75533-A	1/36	22
1"	18	H-75544-A	1/36	28
<b>Press</b>				
3/4"	9	H-78533-A	1/36	22
1"	18	H-78544-A	1/36	28
<b>BODY ONLY - INSTALL W/ (2) G-UNION FITTINGS</b>				
<b>G-Thread</b>				
1"	9	H-70530-A	1/36	22
1"	18	H-70540-A	1/36	28

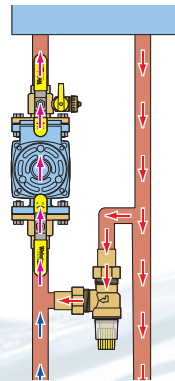

*Under partial loads, the DPBV opens to ensure quiet operation and appropriate pressures at the boiler circulator. With all zones active, the DPBV remains closed*

# CHECK VALVES



## FORGED DZR BRASS IN-LINE SPRING CHECK VALVE

Stainless Steel Spring - Soft Seat

### LEAD-FREE BRASS

Certified to NSF/ANSI 61 & 372

SIZE	ITEM#	CTN/CASE	CASE WT
<b>Press</b>			
200 PSI CWP Max/250°F Max			
1/2"	H-10782W	10/60	37
3/4"	H-10783W	10/40	33
1"	H-10784W	6/24	31
1 1/4"	H-10785W	6/12	25
1 1/2"	H-10786W	6/12	32
2"	H-10787W	1/6	23
<b>FIP</b>			
200 PSI CWP Max/250°F Max			
3/8"	H-10741W	10/100	19
1/2"	H-10742W	10/100	30
3/4"	H-10743W	10/60	31
1"	H-10744W	10/40	29
1 1/4"	H-10745W	6/24	24
1 1/2"	H-10746W	6/24	29
2"	H-10747W	6/12	22
<b>SWT</b>			
200 PSI CWP Max/250°F Max			
3/8"	H-10751W	10/100	19
1/2"	H-10752W	10/100	30
3/4"	H-10753W	10/60	31
1"	H-10754W	10/40	29
1 1/4"	H-10755W	6/24	24
1 1/2"	H-10756W	6/24	29
2"	H-10757W	6/12	22

## PROPUSH IN-LINE SPRING CHECK VALVE

Forged DZR Brass Fitting - For Connection to Copper, CPVC or PEX

### LEAD-FREE BRASS

Certified to NSF/ANSI 61 & 372, ASSE 1061

SIZE	ITEM#	CTN/CASE	CASE WT
<b>Push</b>			
200 PSI CWP Max/200°F Max			
1/2"	H-26992W-B	6/120	20
3/4"	H-26993W	12/120	39
1"	H-26994W-B	3/45	25

## FORGED BRASS SWING CHECK VALVE

Hard Seat

### LEAD-FREE BRASS







Certified to NSF/ANSI 61-G

SIZE	ITEM#	CTN/CASE	CASE WT
<b>FIP</b>			
200 PSI CWP MAX/125 WSP			
1/4"	H-10540W	12/120	27
3/8"	H-10541W	10/120	35
1/2"	H-10542W	10/120	49
3/4"	H-10543W	10/80	49
1"	H-10544W	5/60	51
1 1/4"	H-10545W	5/40	56
1 1/2"	H-10546W	5/30	60
2"	H-10547W	2/12	34
2 1/2"	H-10548W	2/8	38
3"	H-10549W	1/8	61
4"	H-10550W	1/4	47
<b>SWT</b>			
200 PSI CWP Max/125 WSP			
1/2"	H-10622W	10/120	50
3/4"	H-10623W	10/80	51
1"	H-10624W	5/60	54
1 1/4"	H-10625W	5/40	59
1 1/2"	H-10626W	5/30	63
2"	H-10627W	2/10	31



# G-UNION FITTINGS & ACCESSORIES

- Multiple options to customize your installation and simplify future service
- Eliminate additional adapters or connect different piping materials
- Replace or add to included G-Union fittings, or start with a G-Thread body for a fully custom installation
- Match the G-Thread size with the accessory/ fitting G-Union size

G-UNION SIZE	SYSTEM PIPING	FIP	MIP	SWT	Press	Push	F1960 PEX	F1807 PEX
								
<b>Forged DZR Brass Fitting</b>								
1"	1/2"	H-7-2102W WP	H-7-4102W WP	H-7-5102W WP	H-7-8102W WP	H-7-6102W WP	H-7-3102W WP	H-7-1102W WP
1"	3/4"	H-7-2103W WP	H-7-4103W WP	H-7-5103W WP	H-7-8103W WP	H-7-6103W WP	H-7-3103W WP	H-7-1103W WP
1"	1"	H-7-2104W WP	H-7-4104W WP	H-7-5104W WP	H-7-8104W WP	-	-	-
1 1/2"	1 1/4"	H-7-2165W WP	H-7-4165W WP	H-7-5165W WP	H-7-8165W WP	-	-	-
1 1/2"	1 1/2"	H-7-2166W WP	H-7-4166W WP	H-7-5166W WP	H-7-8166W WP	-	-	-
<b>Forged DZR Brass Fitting with Integral Check Valve</b>								
1"	1/2"	H-7-2202W WP	H-7-4202W WP	H-7-5202W WP	H-7-8202W WP	H-7-6202W WP	H-7-3202W WP	H-7-1202W WP
1"	3/4"	H-7-2203W WP	H-7-4203W WP	H-7-5203W WP	H-7-8203W WP	H-7-6203W WP	H-7-3203W WP	H-7-1203W WP
1"	1"	H-7-2204W WP	H-7-4204W WP	H-7-5204W WP	H-7-8204W WP	-	-	-



**ISOLATION BALL VALVE**  
Full Port Forged DZR Brass Valve

**LEAD-FREE BRASS**  
Certified to NSF/ANSI 61 & 372

SIZE	ITEM#	CTN/CASE
G-Union x G-Thread		150 PSI CWP Max
W/ REVERSIBLE YELLOW HANDLE		
1"	H-7-G134WY	10/60
W/ INTEGRAL CHECK VALVE & REVERSIBLE RED HANDLE		
1"	H-7-G234WR	10/60
W/ INTEGRAL CHECK VALVE & REVERSIBLE BLUE HANDLE		
1"	H-7-G234WB	10/60



**ISOLATOR W/ ROTATING FLANGE**  
Full Port Forged DZR Brass Uni-Flange Ball Valve - w/ Detachable Rotating Flange, Adjustable Packing Gland, Nuts & Bolts

**LEAD-FREE BRASS**  
Certified to NSF/ANSI 61 & 372

SIZE	ITEM#	HV ITEM#	CTN/CASE
G-Union x Rotating Flange			600 PSI CWP Max
1"	H-G1404W	H-G1404WHV	1/20
W/ MULTI-FUNCTION HI-FLOW HOSE DRAIN			
1"	H-G1414W	H-G1414WHV	1/20

HV ITEMS FIT HIGH VELOCITY & STANDARD SIZE PUMPS.



**DUAL SCALE TEMPERATURE GAUGE**  
w/ Integrated Forged Brass Fitting - 1/2" Dial Temperature Range 32° - 248°F

**LEAD-FREE BRASS**  
Certified to NSF/ANSI 61 & 372

SIZE	ITEM#	CTN/CASE
G-Union x G-Thread		
1"	H-32000W	10/100

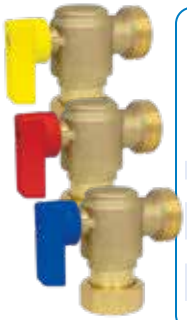

**ANGLED ISOLATION BALL VALVE**  
Full Port Forged DZR Brass Valve

**LEAD-FREE BRASS**  
Certified to NSF/ANSI 61 & 372

SIZE	ITEM#	CTN/CASE
G-Union x G-Thread		150 PSI CWP Max
W/ REVERSIBLE YELLOW HANDLE		
1"	H-7-G134WY-A	10/60
W/ INTEGRAL CHECK VALVE & REVERSIBLE RED HANDLE		
1"	H-7-G234WR-A	10/60
W/ INTEGRAL CHECK VALVE & REVERSIBLE BLUE HANDLE		
1"	H-7-G234WB-A	10/60



**G1 UNION ELBOW**  
Forged DZR Brass Fitting

**LEAD-FREE BRASS**  
Certified to NSF/ANSI 61 & 372

SIZE	ITEM#	CTN/CASE
G-Union x G-Thread		150 PSI CWP Max
1"	H-7-G144W-A	10/60



## HIGH-TEMP CHECK VALVES

Replaces included in-line check valves when using select isolation ball valves with high-temp solar heat sources



**SET OF 2 IN-LINE CHECK INSERTS & RETAINING RINGS**  
For Use With Webstone G1 Fittings For Solar Applications - Max Input 230°F

SIZE	ITEM#	CTN/CASE
		150 PSI CWP Max/230°F Max
3/4"	H-C7-303	10/100

G-THREAD SIZES						
G-UNION SIZE	VERTICAL AIR SEPARATOR	MAGNETIC BOILER FILTER	MAGNETIC BOILER FILTER XL	DIFFERENTIAL PRESSURE BY-PASS VALVE	ANGLED DIFFERENTIAL PRESSURE BY-PASS VALVE	THERMOSTATIC MIXING VALVES
	1"	1"	1 1/2"	1"	1"	1"
						
BODY ONLY ITEM#	H-71000-V	H-70700	H-70706	H-70530 9 GPM MAX H-70540 18 GPM MAX	H-70530-A 9 GPM MAX H-70540-A 18 GPM MAX	H-70000W-CAN 95°-120°F H-70000W 95°-131°F H-70070W 104°-176°F H-70060W 104°-176°F (230°F Max Input)
PRODUCT DETAILS	See Page 20	See Page 22	See Page 23	See Page 24	See Page 24	See Page 4

# WHERE WOULD YOU USE WEBSTONE?

## SAVE TIME, SAVE SPACE & SAVE LABOR

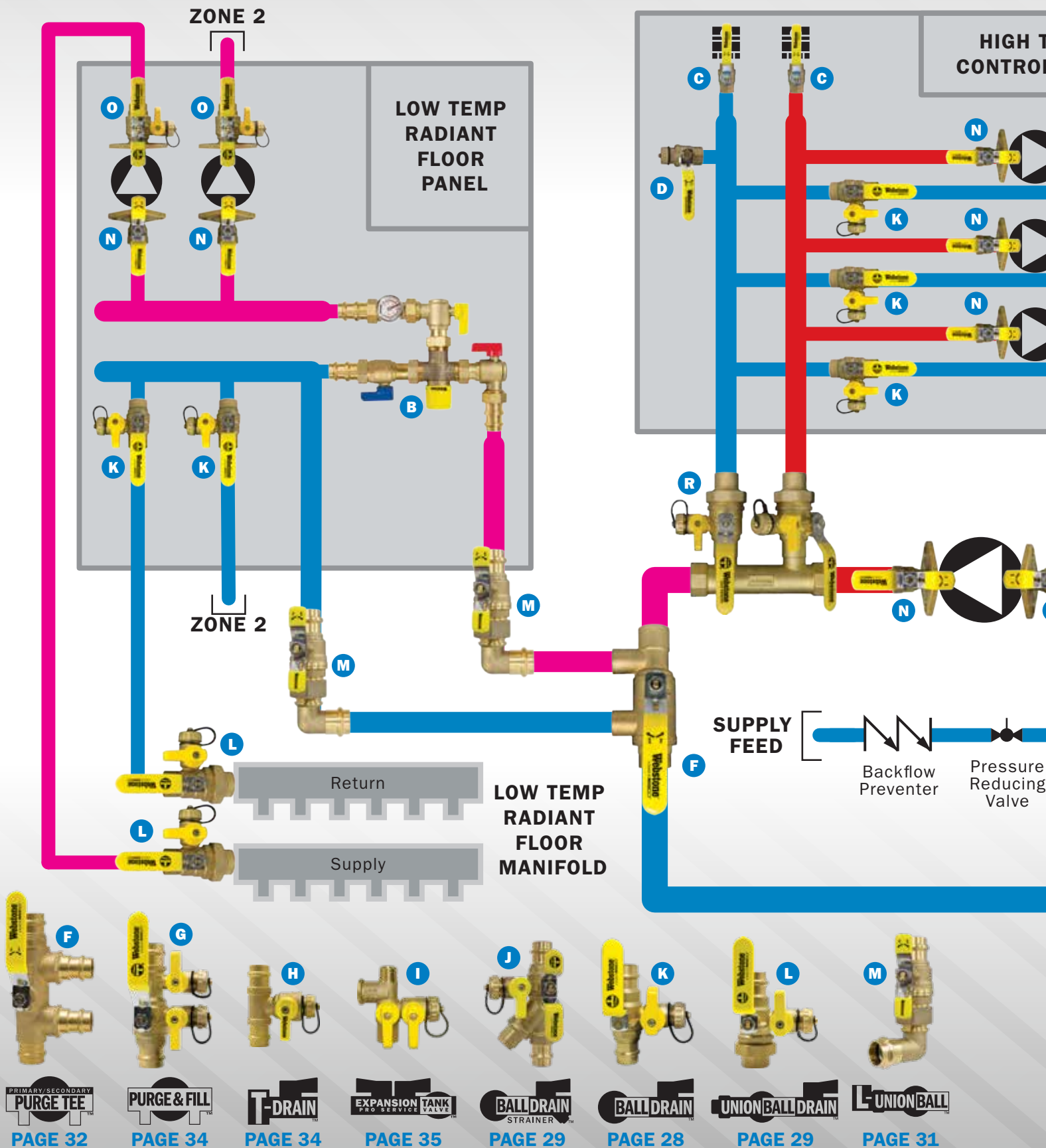



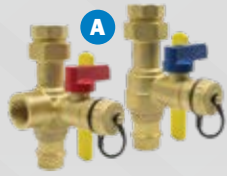

TWH SERVICE VALVES  
**E·X·P**  
S E R I E S

**PAGE 10**

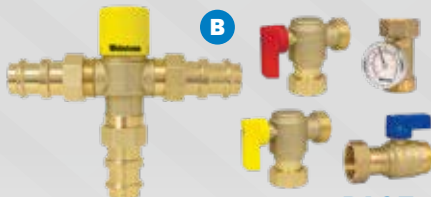

**THERMOSTATIC MIXING VALVE  
W/G-UNION ACCESSORIES**

**PAGE 4**



**BRASS BALL VALVE  
PAGE 46**



**BALL VALVE  
W/ HOSE END  
PAGE 48**



**GAS SEDIMENT TRAP  
PAGE 15**

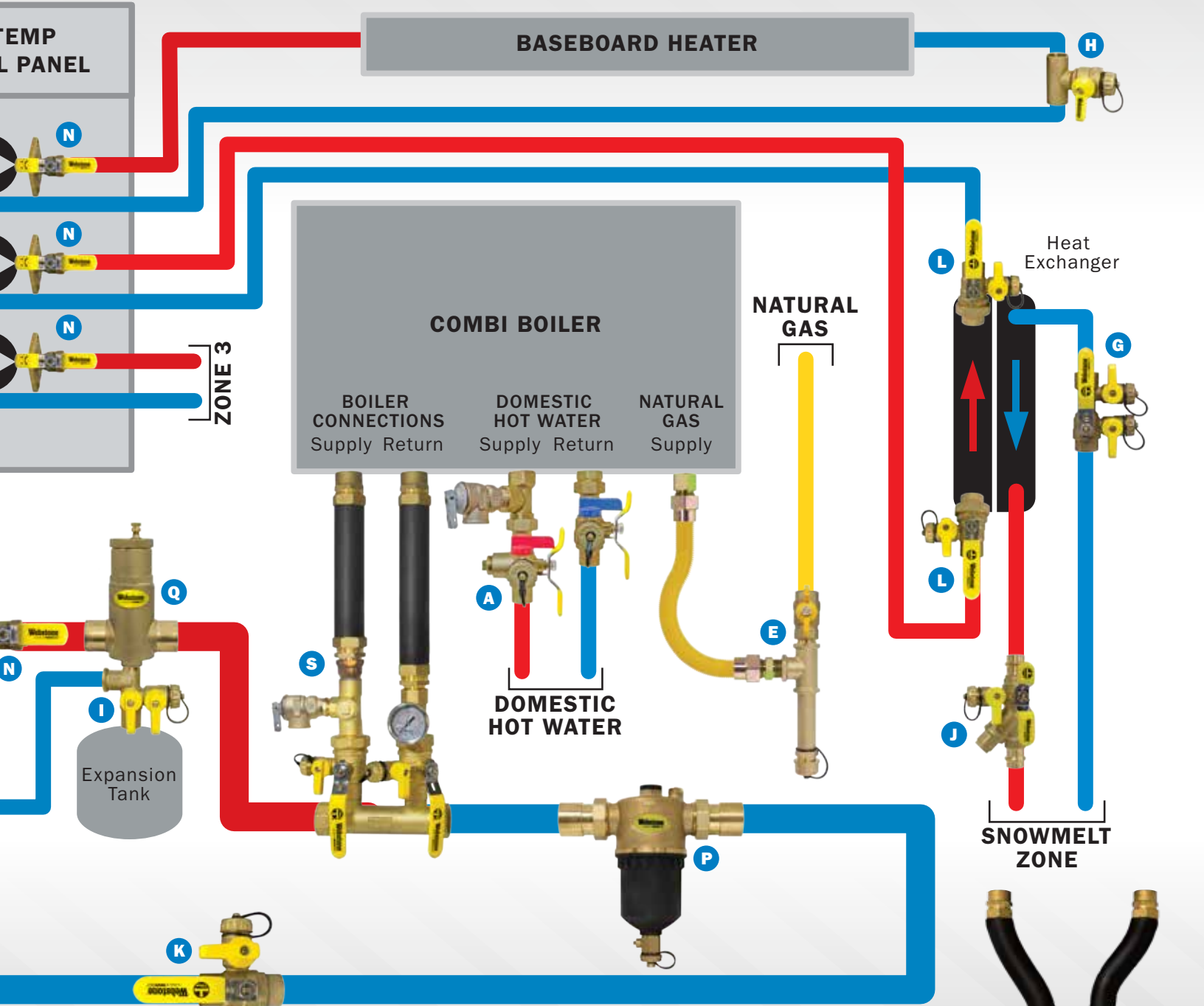

**The ISOLATOR**  
UNI-FLANGE BALL VALVE  
W/ ROTATING FLANGE

**PAGE 36**



**The ISOLATOR**  
UNI-FLANGE BALL VALVE  
W/ ROTATING FLANGE &  
MULTI-FUNCTION DRAIN

**PAGE 36**

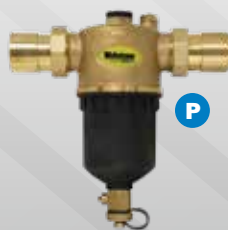

**MAGNETIC  
BOILER FILTER XL**

**PAGE 23**



**AIR  
SEPARATOR**

**PAGE 21**



**HYDRO-CORE**  
MANIFOLD

**PAGE 17**

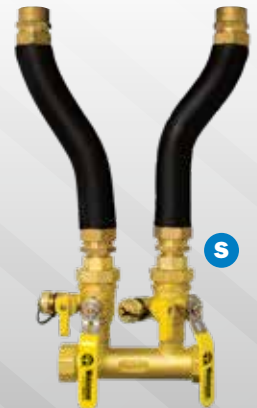

**HYDRO-CORE**  
COMPLETE NEAR BOILER PIPING KIT

**PAGE 18**



# STEP SAVING VALVES FOR THE PROFESSIONAL

PATENTED TECHNOLOGY WITH FURTHER PATENTS PENDING



- Eliminates assemblies needed to isolate & drain any portion of a piped system
- Press or SWT × FIP options designed specifically for use with pre-fabricated threaded headers
- Avoids reduced-port alternatives
- Creates cleaner-looking, more efficient installations
- Reversible handle for added versatility
- Exclusive adjustable flow path allows for draining from either side of the ball

## BALL DRAIN

Full Port Forged Brass Ball Valve w/ Hi-Flow Hose Drain, Reversible Handle & Adjustable Packing Glands

### STANDARD BRASS

### LEAD-FREE BRASS

Certified to NSF/ANSI 61 & 372

SIZE	ITEM#	CTN/CASE	CASE WT	ITEM#	CTN/CASE	CASE WT
<b>FIP</b>						
600 PSI CWP Max/350°F Max						
1/2"	H-40612	6/36	32	H-40612W	6/36	32
3/4"	H-40613	6/36	40	H-40613W	6/36	40
1"	H-40614	4/24	39	H-40614W	4/24	38
1 1/4"	H-40615	2/12	27	H-40615W	2/12	27
1 1/2"	H-40616	2/12	37	H-40616W	2/8	26
2"	H-40617	1/6	29	H-40617W	1/6	29
<b>SWT</b>						
600 PSI CWP Max/250°F Max						
1/2"	H-50612	6/36	29	H-50612W	6/36	29
3/4"	H-50613	6/36	39	H-50613W	6/36	39
1"	H-50614	4/24	38	H-50614W	4/24	37
1 1/4"	H-50615	2/12	27	H-50615W	2/12	27
1 1/2"	H-50616	2/12	41	H-50616W	2/8	27
2"	H-50617	1/6	32	H-50617W	1/6	30
<b>SWT × FIP</b>						
500 PSI CWP Max/250°F Max						
1/2"	H-54612	6/36	30	H-54612W	6/36	30
3/4"	H-54613	6/36	40	H-54613W	6/36	39
1"	H-54614	4/24	37	H-54614W	4/24	37
<b>Press</b>						
250 PSI CWP Max/250°F Max						
1/2"	H-80612	4/40	39	H-80612W	4/40	38
3/4"	H-80613	4/32	40	H-80613W	4/32	40
1"	H-80614	2/20	35	H-80614W	2/20	35
1 1/4"	H-80615	2/16	43	H-80615W	2/16	43
1 1/2"	H-80616	1/8	29	H-80616W	1/8	29
2"	H-80617	1/6	34	H-80617W	1/6	34
<b>Press × FIP</b>						
250 PSI CWP Max/250°F Max						
3/4"	H-84613	4/32	37	-	-	-
1"	H-84614	2/20	33	-	-	-
<b>Press × F1960 PEX*</b>						
250 PSI CWP Max/250°F Max						
1/2"	-	-	-	H-83612W	4/40	38
3/4"	-	-	-	H-83613W	4/32	30
1"	-	-	-	H-83614W	2/20	19
1 1/4"	-	-	-	H-83615W	2/16	43
1 1/2"	-	-	-	H-83616W	1/8	30
2"	-	-	-	H-83617W	1/6	37
<b>Press × F1807 PEX*</b>						
250 PSI CWP Max/250°F Max						
1/2"	-	-	-	H-81612W	4/40	38
3/4"	-	-	-	H-81613W	4/32	30
1"	-	-	-	H-81614W	2/20	19
1 1/4"	-	-	-	H-81615W	2/16	42
1 1/2"	-	-	-	H-81616W	1/8	29
2"	-	-	-	H-81617W	1/6	34
<b>F1960 PEX*</b>						
400 PSI CWP Max/200°F Max						
1/2"	-	-	-	H-30612W	4/40	35
3/4"	-	-	-	H-30613W	4/32	37
1"	-	-	-	H-30614W	2/20	32
1 1/4"	-	-	-	H-30615W	2/16	40
1 1/2"	-	-	-	H-30616W	1/8	28
2"	-	-	-	H-30617W	1/6	33
<b>F1807 PEX*</b>						
400 PSI CWP Max/200°F Max						
1/2"	-	-	-	H-10612W	4/40	34
3/4"	-	-	-	H-10613W	4/32	35
1"	-	-	-	H-10614W	2/20	31
1 1/4"	-	-	-	H-10615W	2/16	37
1 1/2"	-	-	-	H-10616W	1/8	26
2"	-	-	-	H-10617W	1/6	30

\* CERTIFIED TO NSF/ANSI 61 & 372, NSF/ANSI 14

## THE OLD WAY

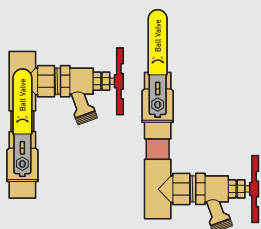

Draining from Above Ball    Draining from Below Ball

## THE WEBSTONE WAY

REPLACES **4** COMPONENTS    SAVES **27** MINUTES    ELIMINATES **3** LEAK PATHS



### T-Flow Ball



Adjustable stem directs flow into the hi-flow hose drain from either side of the ball

### DRAINING FROM AFTER BALL

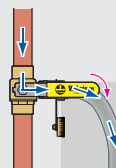
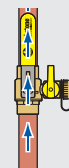

### DRAINING FROM BEFORE BALL

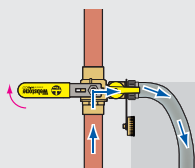
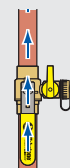



- Integrated Y-strainer saves space and protects system from debris
- Suitable for vertical or horizontal installation
- O-ring sealed and plugged strainer port for easy removal of filter and installation of drain valve

#### BALL DRAIN STRAINER

Full Port Forged DZR Brass Ball Valve w/ Hi-Flow Multi-Function Hose Drain, Integral Y-Strainer (20 Mesh), 1/2" Plugged NPT Port & Adjustable Packing Glands

#### LEAD-FREE BRASS

Certified to NSF/ANSI 61 & 372

SIZE	ITEM#	CTN/CASE	CASE WT
<b>FIP</b>			
250 PSI CWP Max/200°F Max			
1/2"	H-41562W	4/32	35
3/4"	H-41563W	2/24	40
1"	H-41564W	2/20	44
1 1/4"	H-41565W	2/12	42
<b>Press</b>			
250 PSI CWP Max/200°F Max			
1/2"	H-81562W	2/24	29
3/4"	H-81563W	2/20	36
1"	H-81564W	2/12	28
1 1/4"	H-81565W	2/8	30

#### THE OLD WAY

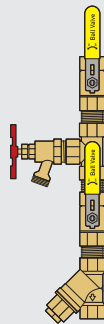

**THE WEBSTONE WAY**  
 REPLACES **8** COMPONENTS  
 SAVES **63** MINUTES  
 ELIMINATES **7** LEAK PATHS



#### Simplifies System Service

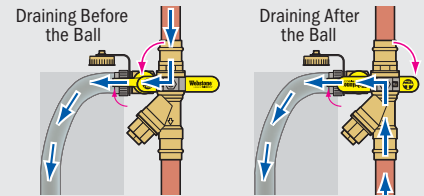

#### Simplifies Strainer Service

See [webstonevalves.com/instructions](http://webstonevalves.com/instructions) for full service procedure and important safety information.

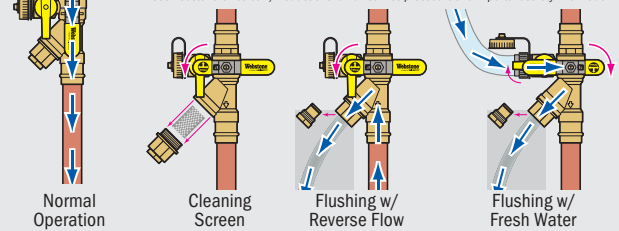

## UNION BALL DRAIN

- All the features of the ball drain, with integrated union connection

#### UNION BALL DRAIN

Full Port Forged Brass Ball Valve w/ Single Union End, Hi-Flow Hose Drain, Reversible Handle & Adjustable Packing Glands

#### STANDARD BRASS

SIZE	ITEM#	CTN/CASE	CASE WT
<b>FIP Union * FIP</b>			
3/4"	H-40433	6/24	41
1"	H-40434	4/16	36
1 1/4"	H-40435	2/12	40
1 1/2"	H-40436	2/12	56
<b>FIP Union * SWT</b>			
3/4"	H-50433	6/24	40
1"	H-50434	4/16	36
1 1/4"	H-50435	2/12	38
1 1/2"	H-50436	2/12	56
<b>FIP Union * Press</b>			
3/4"	-	-	-
1"	-	-	-
1 1/4"	-	-	-
1 1/2"	-	-	-
<b>FIP Union * F1960 PEX*</b>			
1/2"	-	-	-
3/4"	-	-	-
1"	-	-	-
1 1/4"	-	-	-
1 1/2"	-	-	-
2"	-	-	-
<b>FIP Union * F1807 PEX*</b>			
1/2"	-	-	-
3/4"	-	-	-
1"	-	-	-
1 1/4"	-	-	-
1 1/2"	-	-	-
2"	-	-	-

#### LEAD-FREE BRASS

Certified to NSF/ANSI 61 & 372

SIZE	ITEM#	CTN/CASE	CASE WT
<b>600 PSI CWP Max/350°F Max</b>			
3/4"	H-40433W	6/24	40
1"	H-40434W	4/16	36
1 1/4"	H-40435W	2/12	38
1 1/2"	H-40436W	2/8	38
<b>600 PSI CWP Max/250°F Max</b>			
3/4"	H-50433W	6/24	39
1"	H-50434W	4/16	31
1 1/4"	H-50435W	2/12	38
1 1/2"	H-50436W	2/8	38
<b>250 PSI CWP Max/250°F Max</b>			
3/4"	H-80433W	4/16	28
1"	H-80434W	2/16	36
1 1/4"	H-80435W	2/8	27
1 1/2"	H-80436W	1/5	25
<b>250 PSI CWP Max/200°F Max</b>			
1/2"	H-30432W	4/16	22
3/4"	H-30433W	4/16	27
1"	H-30434W	2/16	36
1 1/4"	H-30435W	2/8	27
1 1/2"	H-30436W	1/8	39
2"	H-30437W	1/4	29
<b>250 PSI CWP Max/200°F Max</b>			
1/2"	H-10432W	4/16	22
3/4"	H-10433W	4/16	27
1"	H-10434W	2/16	35
1 1/4"	H-10435W	2/8	26
1 1/2"	H-10436W	1/8	38
2"	H-10437W	1/4	28

CERTIFIED TO NSF/ANSI 61 & 372, NSF/ANSI 14

#### THE OLD WAY

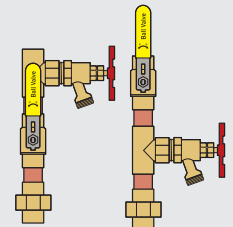

Draining from Above Ball    Draining from Below Ball

#### THE WEBSTONE WAY

REPLACES **6** COMPONENTS  
 SAVES **45** MINUTES  
 ELIMINATES **5** LEAK PATHS



Winterize an entire building with simple quarter-turn actions

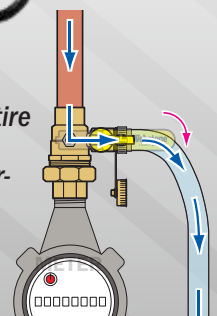



ALSO AVAILABLE

TWH SERVICE VALVES  
**E·X·P**  
UNION BALL

Ideal for tanked and next-gen tankless water heater connections - See Page 13

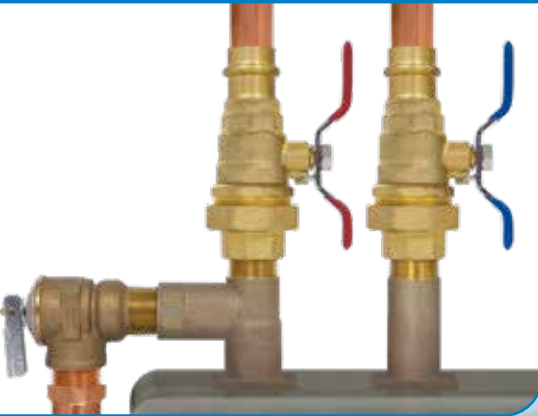

# UNIONBALL™

- Easily disconnect and replace any portion of a piped system

## UNION BALL

Full Port Forged DZR Brass Ball Valve w/ Single Union End & Adjustable Packing Gland

### LEAD-FREE BRASS

Certified to NSF/ANSI 61 & 372

SIZE	ITEM#	CTN/CASE	CASE WT
<b>FIP Union × FIP</b> 250 PSI CWP Max/200°F Max			
1/2"	H-40422W	5/40	35
3/4"	H-40423W	4/32	41
1"	H-40424W	4/20	37
<b>FIP Union × SWT</b> 250 PSI CWP Max/200°F Max			
1/2"	H-50422W	5/40	33
3/4"	H-50423W	4/32	40
1"	H-50424W	4/20	36
<b>FIP Union × Press</b> 250 PSI CWP Max/200°F Max			
1/2"	H-80422W	5/40	37
3/4"	H-80423W	4/32	43
1"	H-80424W	4/20	34
<b>FIP Union × Push</b> 200 PSI CWP Max/200°F Max			
1/2"	H-60422W*	5/40	34
3/4"	H-60423W*	4/32	38
1"	H-60424W*	4/20	38
<b>FIP Union × F1960 PEX</b> 250 PSI CWP Max/200°F Max			
1/2"	H-30422W†	5/40	33
3/4"	H-30423W†	4/32	40
1"	H-30424W†	4/20	36
<b>FIP Union × F1807 PEX</b> 250 PSI CWP Max/200°F Max			
1/2"	H-10422W†	5/40	33
3/4"	H-10423W†	4/32	40
1"	H-10424W†	4/20	36

\* CERTIFIED TO NSF/ANSI 61 & 372, NSF/ANSI 14, ASSE 1061

† CERTIFIED TO NSF/ANSI 61 & 372, NSF/ANSI 14



### THE OLD WAY



### THE WEBSTONE WAY

REPLACES SAVES ELIMINATES

**3** **18** **2**  
COMPONENTS MINUTES LEAK PATHS

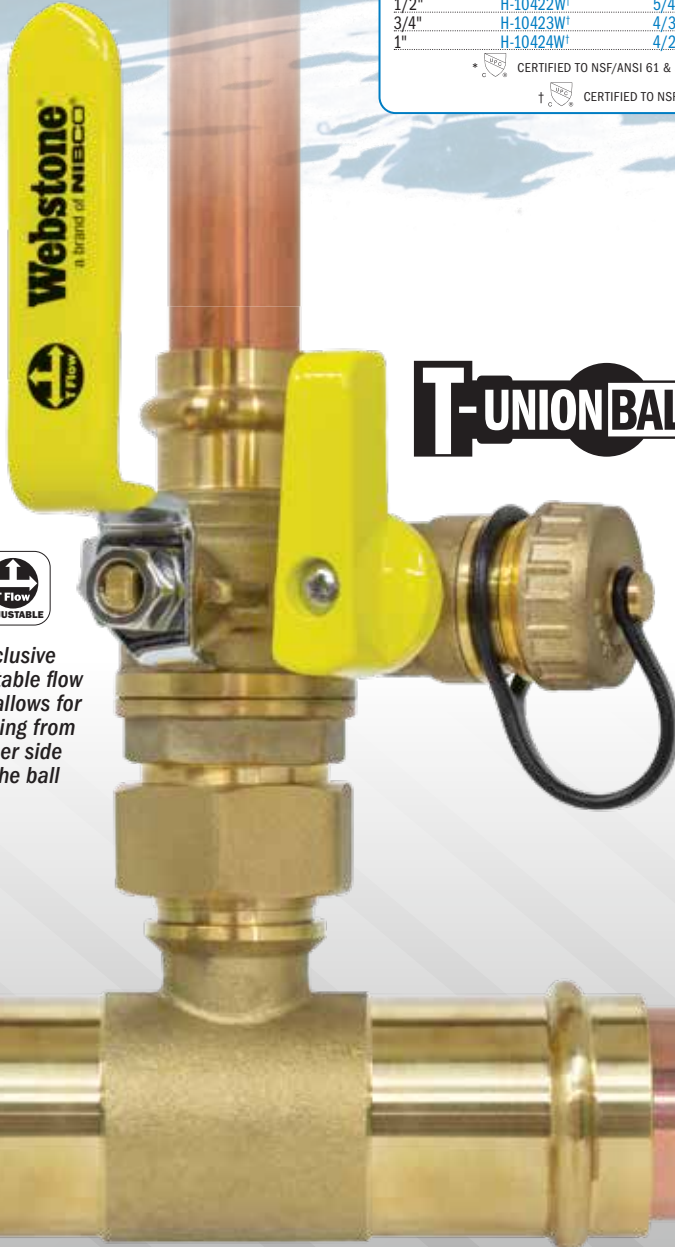

Exclusive adjustable flow path allows for draining from either side of the ball

# T-UNIONBALL DRAIN™

- Ideal for branch connections and shutoffs in tight locations
- Dual stem seal design incorporates both an O-ring and PTFE packing with adjustable packing gland for extra leak protection

## T-UNION BALL DRAIN

Full Port Forged DZR Brass Ball Valve w/ Union Tee, Hi-Flow Hose Drain, Reversible Handle & Dual Stem Seal Design

### LEAD-FREE BRASS

Certified to NSF/ANSI 61 & 372

SIZE	ITEM#	CTN/CASE	CASE WT
<b>Press Valve × Press Run</b> 250 PSI CWP Max/200°F Max			
3/4" × 1 1/4"	H-80633W-T114	1/12	28
1" × 1 1/4"	H-80634W-T114	1/8	24
1" × 1 1/2"	H-80634W-T112	1/8	26
1 1/4" × 1 1/2"	H-80635W-T112	1/6	23

### THE OLD WAY



Draining from Above Ball



Draining from Below Ball

### THE WEBSTONE WAY

REPLACES SAVES ELIMINATES

**8** **63** **7**  
COMPONENTS MINUTES LEAK PATHS



# T-UNION BALL™

- Ideal for branch connections and shutoffs in tight locations
- Integrated union fitting adds versatility and simplifies installation
- Dual stem seal design incorporates both an O-ring and PTFE packing with adjustable packing gland for extra leak protection

**THE OLD WAY**

**THE WEBSTONE WAY**

REPLACES **5** COMPONENTS   SAVES **36** MINUTES   ELIMINATES **4** LEAK PATHS

**T-UNION BALL**  
Full Port Forged DZR Brass Ball Valve w/  
Union Tee & Dual Stem Seal Design

**LEAD-FREE BRASS**  
Certified to NSF/ANSI 61 & 372

SIZE	ITEM#	CTN/CASE	CASE WT
Press Valve × Press Run		250 PSI CWP Max/200°F Max	
1/2"	H-83712W	5/40	33
3/4"	H-83713W	5/30	39
3/4" × 1 1/4"	H-83713W-T114	2/16	31
1"	H-83714W	4/16	35
1" × 1 1/4"	H-83714W-T114	2/8	21
1" × 1 1/2"	H-83714W-T112	2/8	23
1 1/4" × 1 1/2"	H-83715W-T112	2/8	29

LEVER HANDLE ON H-83715W-T112

# L-UNION BALL™

- Ideal for shutoffs in tight locations
- Integrated union fitting adds versatility and simplifies installation
- Dual stem seal design incorporates both an O-ring and PTFE packing with adjustable packing gland for extra leak protection

**THE OLD WAY**

**THE WEBSTONE WAY**

REPLACES **5** COMPONENTS   SAVES **36** MINUTES   ELIMINATES **4** LEAK PATHS

**L-UNION BALL**  
Full Port Forged DZR Brass Ball Valve w/ 90°  
Union Elbow & Dual Stem Seal Design

**LEAD-FREE BRASS**  
Certified to NSF/ANSI 61 & 372

SIZE	ITEM#	CTN/CASE	CASE WT
Press		250 PSI CWP Max/200°F Max	
1/2"	H-82712W	5/40	31
3/4"	H-82713W	5/30	36
1"	H-82714W	4/16	32







- Ideal for primary/secondary piping in mod-con boiler systems
- Provides precise spacing required for hydraulic separation
- Enables power purging of secondary loops, improving efficiency at system startup
- The only way to place a valve between closely spaced tees

**PURGE TEE**

Full Port Forged Brass Ball Valve w/ Reversible Handle & Adjustable Packing Gland

STANDARD BRASS			
SIZE	ITEM#	CTN/CASE	CASE WT
<b>SWT (1" Primary Loop)</b>			
1" x 3/4"	H-58643	1/12	23
1" x 1"	H-58644	1/12	24
<b>SWT (1 1/4" Primary Loop)</b>			
1 1/4" x 3/4"	H-58653	1/12	39
1 1/4" x 1"	H-58654	1/12	38
1 1/4" x 1 1/4"	H-58655	1/12	37
<b>Press (1" Primary Loop)</b>			
		250 PSI CWP Max/250°F Max	
1" x 3/4"	H-88643	1/12	34
1" x 1"	H-88644	1/12	34
<b>Press (1 1/4" Primary Loop)</b>			
		250 PSI CWP Max/250°F Max	
1 1/4" x 1"	H-88654	1/12	51
1 1/4" x 1 1/4"	H-88655	1/12	52

**THE OLD WAY**



**THE WEBSTONE WAY**

REPLACES 5 COMPONENTS SAVES 36 MINUTES ELIMINATES 4 LEAK PATHS

\*Correct spacing for hydraulic separation cannot be achieved using off-the-shelf components.

**POWER PURGING**

Fluid is rapidly forced through the secondary loop, purging excess air from system through the drain

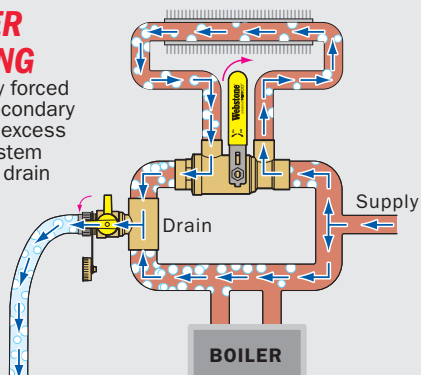

- Ideal for branch or device connections in tight locations
- Lead-free DZR brass construction
- Replaces multiple components
- Saves labor, space, and leak paths

**T-VALVE**

Full Port Forged DZR Brass Ball Valve w/ Integrated Tee Fitting, Adjustable Packing Gland, & Reversible Handle

**LEAD-FREE BRASS**

Certified to NSF/ANSI 61 & 372

SIZE	ITEM#	CTN/CASE	CASE WT
<b>FIP Valve x Press Run</b>			
		250 PSI CWP Max/250°F Max	
1/2"	H-82672W	4/40	23
1/2" x 3/4"	H-82672W-T34	4/16	16
3/4"	H-82673W	4/16	16

**THE OLD WAY**

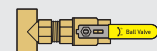

**THE WEBSTONE WAY**

REPLACES 3 COMPONENTS SAVES 18 MINUTES ELIMINATES 2 LEAK PATHS



# 3-WAY L-PORT BALL VALVE™

- Divert or select fluids based on application needs
- Dual stem seal design incorporates both an O-ring and PTFE packing with adjustable packing gland for extra leak protection



## 90° Handle Operation

Ideal for use as a diverter or selector valve

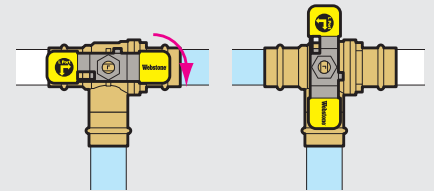

**THE OLD WAY**

**THE WEBSTONE WAY**

REPLACES SAVES ELIMINATES  
**5** **36** **4**  
COMPONENTS MINUTES LEAK PATHS

### 3-WAY L-PORT BALL VALVE

Forged DZR Brass Ball Valve w/ Dual Stem Seal Design

**LEAD-FREE BRASS**

Certified to NSF/ANSI 61 & 372

SIZE	ITEM#	CTN/CASE	CASE WT
Press		250 PSI CWP Max/200°F Max	
1/2"	H-80642W	6/36	20
3/4"	H-80643W	6/36	33
1"	H-80644W	4/24	34
1 1/4"	H-80645W	2/12	30
1 1/2"	H-80646W	2/8	29
2"	H-80647W	1/6	39

LEVER HANDLE ON SIZES 1 1/4"-2"



# 3-WAY T-FLOW BALL VALVE™

- Divert, select, or mix fluids based on application needs
- Dual stem seal design incorporates both an O-ring and PTFE packing with adjustable packing gland for extra leak protection

### 3-WAY T-FLOW BALL VALVE

Forged DZR Brass Ball Valve w/ Dual Stem Seal Design

**LEAD-FREE BRASS**

Certified to NSF/ANSI 61 & 372

SIZE	ITEM#	CTN/CASE	CASE WT
Press		250 PSI CWP Max/200°F Max	
1/2"	H-80742W	6/36	20
3/4"	H-80743W	6/36	31
1"	H-80744W	4/24	33
1 1/4"	H-80745W	2/12	29
1 1/2"	H-80746W	2/8	28
2"	H-80747W	1/6	37

LEVER HANDLE ON SIZES 1 1/4"-2"

**180° Handle Operation**

Ideal for use as a diverter, selector, or mixing valve

**THE OLD WAY**

**THE WEBSTONE WAY**

REPLACES SAVES ELIMINATES  
**5** **36** **4**  
COMPONENTS MINUTES LEAK PATHS



## PURGE & FILL™

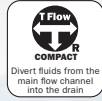

- Simultaneously drain, flush & refill any hydronic, solar, or closed loop system
- T-pattern flow path quickly and easily prevents the flow between the two hose connections
- As fluid is introduced into the system, the existing fluid or air is diverted out of the system through the remaining hose connection
- Reversible handle for added versatility

### PURGE & FILL

Full Port Forged Brass Ball Valve w/ (2) Hi-Flow Hose Drains, Reversible Handle & Adjustable Packing Glands

SIZE	ITEM#	STANDARD BRASS	
		CTN/CASE	CASE WT
<b>FIP</b> 600 PSI CWP Max			
3/4"	H-48613	1/12	20
1"	H-48614	1/12	26
1 1/4"	H-48615	1/12	38
1 1/2"	H-48616	1/12	49
<b>SWT</b> 600 PSI CWP Max			
3/4"	H-58613	1/12	23
1"	H-58614	1/12	26
1 1/4"	H-58615	1/12	38
1 1/2"	H-58616	1/12	51
<b>Press</b> 250 PSI CWP Max/250°F Max			
3/4"	H-88613	1/12	20
1"	H-88614	1/12	27
1 1/4"	H-88615	1/12	40
1 1/2"	H-88616	1/6	27

**THE OLD WAY**

**THE WEBSTONE WAY**

REPLACES **7** COMPONENTS  
SAVES **54** MINUTES  
ELIMINATES **6** LEAK PATHS

### Simultaneously Drain, Flush & Fill

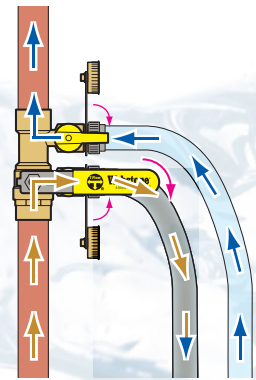

## T-DRAIN™

- Installs anywhere a drain or purge valve is required
- Hi-flow alternative for filling, draining, or venting closed-loop hydronic systems



### T-DRAIN

Full Port Forged Brass Fitting w/ Hi-Flow Hose Drain & Adjustable Packing Gland

#### LEAD-FREE BRASS

Certified to NSF/ANSI 61 & 372

SIZE	ITEM#	CTN/CASE	CASE WT
<b>SWT</b> 600 PSI CWP Max/250°F Max			
1/2"	H-50672W	8/80	42
3/4"	H-50673W	6/48	39
1"	H-50674W	4/40	36
1 1/4"	H-50675W	4/40	43
1 1/2"	H-50676W	2/24	34
2"	H-50677W	2/20	34
<b>Press</b> 250 PSI CWP Max/250°F Max			
1/2"	H-80672W	4/40	25
3/4"	H-80673W	4/16	16
1"	H-80674W	4/16	18
1 1/4"	H-80675W	4/16	20

**THE OLD WAY**

**THE WEBSTONE WAY**

REPLACES **2** COMPONENTS  
SAVES **9** MINUTES  
ELIMINATES **1** LEAK PATH

**HANDLE OPERATION**

Normal Operation  
System Purging





- The 3-way ball controls flow between the expansion tank and the system
- Easily install, isolate, drain & replace any expansion tank
- Quickly connect entire system to the cold water feed
- MIP model for direct connection to air separator or tee
- FIP model allows for distance between tank and system

**THE OLD WAY**

**THE WEBSTONE WAY**

REPLACES **7** COMPONENTS   SAVES **54** MINUTES   ELIMINATES **6** LEAK PATHS

**HANDLE OPERATION**

Normal Operation      System Isolation & Tank Draining

**EXPANSION TANK PRO SERVICE VALVE**  
Full Port Forged Brass Ball Valve w/ Hi-Flow Hose Drain

SIZE	ITEM#	STANDARD BRASS CTN/CASE	CASE WT
MIP/SWT × FIP × FIP × Hose		600 PSI CWP Max/250°F Max	
1/2"	H-41672	1/30	29
FIP × Hose		600 PSI CWP Max	
1/2"	H-44672	1/30	31

**Ideal for use with Horizontal Air Separator**  
**SEE PAGE 21**

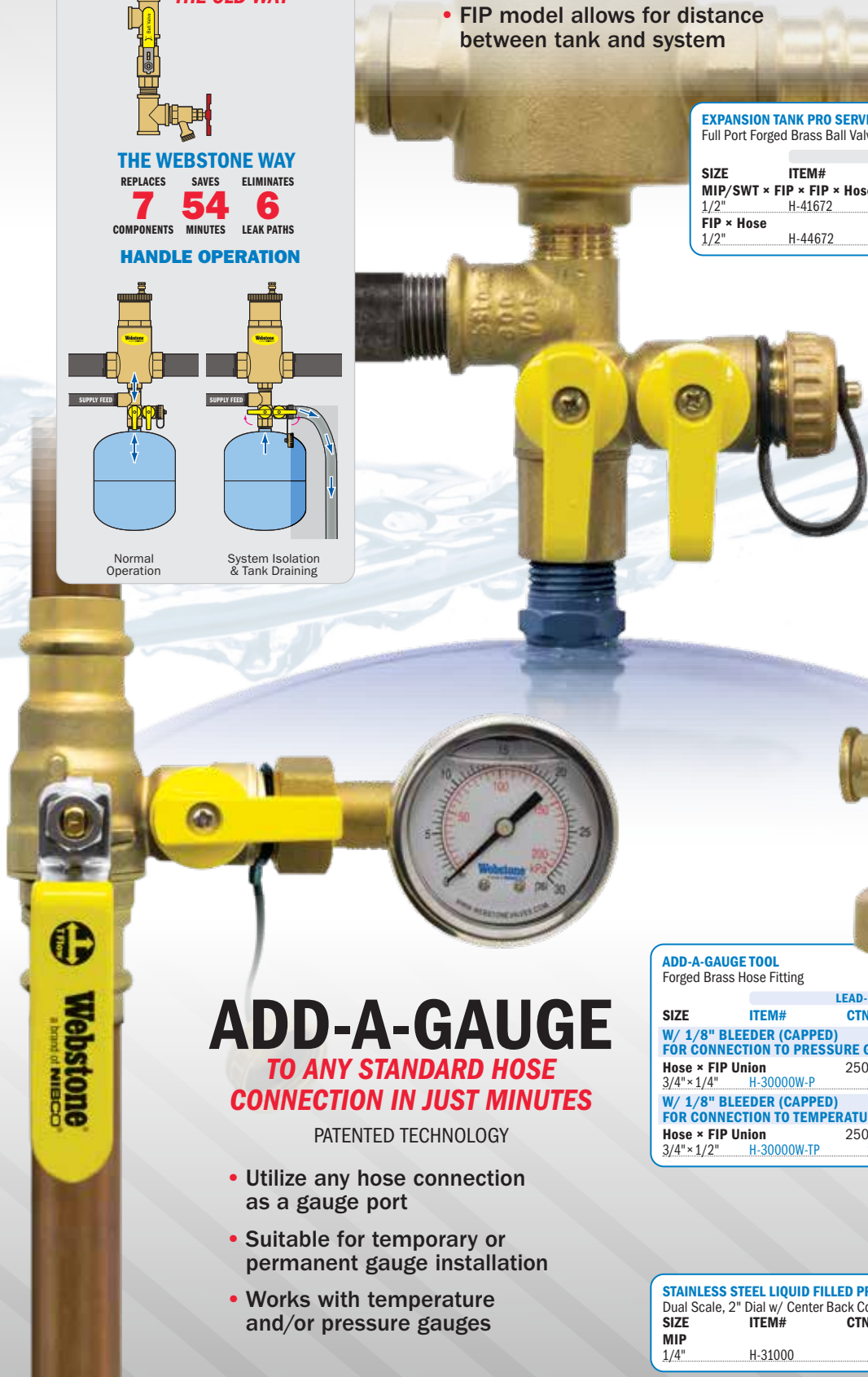

# ADD-A-GAUGE

**TO ANY STANDARD HOSE CONNECTION IN JUST MINUTES**

PATENTED TECHNOLOGY

- Utilize any hose connection as a gauge port
- Suitable for temporary or permanent gauge installation
- Works with temperature and/or pressure gauges



**ADD-A-GAUGE TOOL**  
Forged Brass Hose Fitting

SIZE	ITEM#	LEAD-FREE BRASS CTN/CASE	CASE WT
<b>W/ 1/8" BLEEDER (CAPPED) FOR CONNECTION TO PRESSURE GAUGE</b>			
Hose × FIP Union		250 PSI CWP Max/250°F Max	
3/4" × 1/4"	H-30000W-P	10/100	27
<b>W/ 1/8" BLEEDER (CAPPED) FOR CONNECTION TO TEMPERATURE/PRESSURE GAUGE</b>			
Hose × FIP Union		250 PSI CWP Max/250°F Max	
3/4" × 1/2"	H-30000W-TP	10/100	27

**STAINLESS STEEL LIQUID FILLED PRESSURE GAUGE**  
Dual Scale, 2" Dial w/ Center Back Connection

SIZE	ITEM#	CTN/CASE	CASE WT
MIP		30 PSI CWP MAX	
1/4"	H-31000	1/100	38





# The ISOLATOR<sup>®</sup>

UNI-FLANGE BALL VALVE<sup>®</sup>

# THE ONLY WAY TO ISOLATE CIRCULATOR PUMPS

PATENTED TECHNOLOGY WITH FURTHER PATENTS PENDING

## The ISOLATOR<sup>®</sup>

UNI-FLANGE BALL VALVE<sup>®</sup>  
with ROTATING FLANGE

The features and benefits you trust in our original Isolator line, with two versatile enhancements. The 360° flange rotation allows rotation to any degree necessary for your installation, and the multi-function drain that makes the Isolator the only valve that drains from both sides of the pump!

### THE OLD WAY

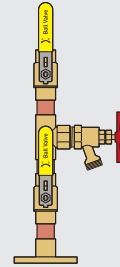

**THE WEBSTONE WAY**  
REPLACES 8 COMPONENTS SAVES 63 MINUTES ELIMINATES 7 LEAK PATHS

### PURGES BEFORE OR AFTER PUMP

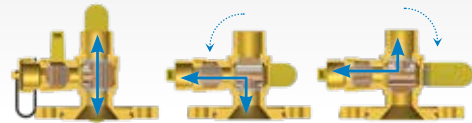

### TWO FLANGE DESIGN OPTIONS

ALSO AVAILABLE W/ ROUND FLANGE FOR HIGH EFFICIENCY VARIABLE SPEED PUMPS - SEE PAGE 38

**ITEM#**  
1/2" HOLE  
FITS STANDARD  
SIZE PUMPS

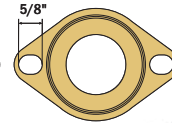
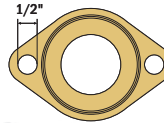

**HV ITEM#**  
5/8" SLOTTED HOLE  
FITS HIGH VELOCITY &  
STANDARD SIZE PUMPS

#### ISOLATOR W/ ROTATING FLANGE

Full Port Forged Brass Uni-Flange Ball Valve w/ Detachable Rotating Flange, Adjustable Packing Gland, Nuts & Bolts

##### STANDARD BRASS

##### LEAD-FREE BRASS

Certified to NSF/ANSI 61 & 372

SIZE	ITEM#	HV ITEM#	CTN/CASE	CASE WT	ITEM#	HV ITEM#	CTN/CASE	CASE WT
<b>FIP × Rotating Flange</b> 600 PSI CWP Max								
3/4"	H-41403	H-41403HV	1/20	27	H-41403W	H-41403WHV	2/20	27
1"	H-41404	H-41404HV	1/20	34	H-41404W	H-41404WHV	2/20	35
1 1/4"	H-41405	H-41405HV	1/20	41	H-41405W	H-41405WHV	2/10	45
1 1/2"	H-41406	H-41406HV	1/20	54	H-41406W	H-41406WHV	2/10	32
2"	-	-	-	-	-	H-41407WHV	1/10	34
<b>SWT × Rotating Flange</b> 600 PSI CWP Max								
3/4"	H-51403	H-51403HV	1/20	25	H-51403W	H-51403WHV	2/20	27
1"	H-51404	H-51404HV	1/20	34	H-51404W	H-51404WHV	2/20	35
1 1/4"	H-51405	H-51405HV	1/20	41	H-51405W	H-51405WHV	2/20	45
1 1/2"	H-51406	H-51406HV	1/20	58	H-51406W	H-51406WHV	2/10	33
2"	-	-	-	-	-	H-51407WHV	1/10	34
<b>Press × Rotating Flange</b> 250 PSI CWP Max/250°F Max								
3/4"	H-81403	H-81403HV	1/20	28	H-81403W	H-81403WHV	1/20	28
1"	H-81404	H-81404HV	1/20	40	H-81404W	H-81404WHV	1/20	40
1 1/4"	H-81405	H-81405HV	1/20	53	H-81405W	H-81405WHV	1/20	53
1 1/2"	H-81406	H-81406HV	1/10	32	H-81406W	H-81406WHV	1/10	32
2"	-	H-81407HV	1/10	36	-	H-81407WHV	1/10	51
<b>F1960 PEX × Rotating Flange*</b> 400 PSI CWP Max								
3/4"	-	-	-	-	H-31403W	H-31403WHV	1/20	27
1"	-	-	-	-	H-31404W	H-31404WHV	1/20	27
<b>F1807 PEX × Rotating Flange*</b> 400 PSI CWP Max								
3/4"	-	-	-	-	H-11403W	H-11403WHV	1/20	27
1"	-	-	-	-	H-11404W	H-11404WHV	1/20	29

#### W/ MULTI-FUNCTION HI-FLOW HOSE DRAIN

SIZE	ITEM#	HV ITEM#	CTN/CASE	CASE WT	ITEM#	HV ITEM#	CTN/CASE	CASE WT
<b>FIP × Rotating Flange</b> 600 PSI CWP Max								
3/4"	H-41413	H-41413HV	1/20	36	H-41413W	H-41413WHV	2/20	35
1"	H-41414	H-41414HV	1/20	43	H-41414W	H-41414WHV	2/20	41
1 1/4"	H-41415	H-41415HV	1/20	54	H-41415W	H-41415WHV	2/10	27
1 1/2"	H-41416	H-41416HV	1/10	38	H-41416W	H-41416WHV	2/10	36
2"	-	-	-	-	-	H-41417WHV	1/10	38
<b>SWT × Rotating Flange</b> 600 PSI CWP Max								
3/4"	H-51413	H-51413HV	1/20	36	H-51413W	H-51413WHV	2/20	36
1"	H-51414	H-51414HV	1/20	43	H-51414W	H-51414WHV	2/20	41
1 1/4"	H-51415	H-51415HV	1/20	54	H-51415W	H-51415WHV	2/10	28
1 1/2"	H-51416	H-51416HV	1/10	38	H-51416W	H-51416WHV	2/10	33
2"	-	-	-	-	-	H-51417WHV	1/10	36
<b>Press × Rotating Flange</b> 250 PSI CWP Max/250°F Max								
3/4"	H-81413	H-81413HV	1/20	40	H-81413W	H-81413WHV	1/20	40
1"	H-81414	H-81414HV	1/20	48	H-81414W	H-81414WHV	1/20	48
1 1/4"	H-81415	H-81415HV	1/10	31	H-81415W	H-81415WHV	1/10	31
1 1/2"	H-81416	H-81416HV	1/10	38	H-81416W	H-81416WHV	1/10	38
2"	-	H-81417HV	1/10	40	-	H-81417WHV	1/10	53
<b>F1960 PEX × Rotating Flange*</b> 400 PSI CWP Max								
3/4"	-	-	-	-	H-31413W	H-31413WHV	1/20	27
1"	-	-	-	-	H-31414W	H-31414WHV	1/20	27
<b>F1807 PEX × Rotating Flange*</b> 400 PSI CWP Max								
3/4"	-	-	-	-	H-11413W	H-11413WHV	1/20	27
1"	-	-	-	-	H-11414W	H-11414WHV	1/20	27

\*2" ISOLATORS HAVE 1 1/2" PORT.

\*ALSO CERTIFIED TO NSF/ANSI 14 & IAPMO ANSI 12157

AVAILABLE W/  
**PRO-CONNECT PPRPRO**  
EXCLUSIVELY FOR  
  
aqualtherm  
SEE PAGE 40

AVAILABLE W/  
**PRO-CONNECT PPRPRO**  
FOR ANY  
PP-R OR PP-RCT  
PIPING SYSTEM  
SEE PAGE 41

# The ISOLATOR<sup>®</sup>

UNI-FLANGE BALL VALVE<sup>®</sup>

These valves have revolutionized the installation of circulator pumps. Our original Isolator Uni-Flange Ball Valve design has evolved into the largest flanged ball valve program in the industry today.

- Conical inlet to minimize turbulence
- Fits virtually any standard circulator pump
- Available slotted holes for high velocity pumps
- Prevents electrolysis
- Eliminates galvanic corrosion



### ISOLATOR UNI-FLANGE BALL VALVE

Full Port Forged Brass Ball Valve w/ Adjustable Packing Gland, Nuts & Bolts

STANDARD BRASS				
SIZE	ITEM#	HV ITEM#	CTN/CASE	CASE WT
<b>FIP × Flange</b>				
1/2"	H-40402	-	1/20	24
3/4"	H-40403	H-40403HV	1/20	29
1"	H-40404	H-40404HV	1/20	35
1 1/4"	H-40405	H-40405HV	1/20	41
1 1/2"	H-40406	H-40406HV	1/20	59
2"	-	H-40407HV	1/10	38
<b>SWT × Flange</b>				
1/2"	H-50402	-	1/20	25
3/4"	H-50403	H-50403HV	1/20	28
1"	H-50404	H-50404HV	1/20	34
1 1/4"	H-50405	H-50405HV	1/20	41
1 1/2"	H-50406	H-50406HV	1/20	58
2"	-	H-50407HV	1/10	40
<b>W/ HI-FLOW HOSE DRAIN</b>				
<b>FIP × Flange</b>				
3/4"	H-40413	H-40413HV	1/20	42
1"	H-40414	H-40414HV	1/20	49
1 1/4"	H-40415	H-40415HV	1/20	62
1 1/2"	H-40416	H-40416HV	1/10	41
2"	-	H-40417HV	1/10	57
<b>SWT × Flange</b>				
3/4"	H-50413	H-50413HV	1/20	41
1"	H-50414	H-50414HV	1/20	50
1 1/4"	H-50415	H-50415HV	1/20	63
1 1/2"	H-50416	H-50416HV	1/10	43
2"	-	H-50417HV	1/10	57

HV ITEMS FIT HIGH VELOCITY & STANDARD SIZE PUMPS.  
2" ISOLATORS HAVE 1 1/2" PORT.



# The ISOLATOR<sup>®</sup>

UNI-FLANGE BALL VALVE<sup>®</sup>

## CIRCULATOR PUMP INSTALLATION KIT

Everything but the pump! Kits include your choice of Isolator & Isolator w/ Drain, two full-faced flange gaskets, and two sets of nuts & bolts



### ISOLATOR PUMP INSTALLATION KIT

Your choice of Isolator & Isolator w/ Drain & 2 Flange Gaskets, Nuts & Bolts

STANDARD BRASS					LEAD-FREE BRASS			
Certified to NSF/ANSI 61 & 372								
SIZE	ITEM#	HV ITEM#	CTN/CASE	CASE WT	ITEM#	HV ITEM#	CTN/CASE	CASE WT
<b>ISOLATOR PUMP INSTALLATION KIT</b>								
<b>FIP × Flange</b>					600 PSI CWP Max			
3/4"	H-40413KIT	H-40413HVKIT	1/10	36	-	-	-	-
1"	H-40414KIT	H-40414HVKIT	1/10	43	-	-	-	-
1 1/4"	H-40415KIT	H-40415HVKIT	1/10	52	-	-	-	-
<b>SWT × Flange</b>					600 PSI CWP Max			
3/4"	H-50413KIT	H-50413HVKIT	1/10	36	-	-	-	-
1"	H-50414KIT	H-50414HVKIT	1/10	43	-	-	-	-
1 1/4"	H-50415KIT	H-50415HVKIT	1/10	54	-	-	-	-
<b>ISOLATOR W/ ROTATING FLANGE PUMP INSTALLATION KIT</b>								
<b>FIP × Rotating Flange</b>					600 PSI CWP Max			
3/4"	H-41413KIT	H-41413HVKIT	1/10	32	H-41413WKIT	H-41413WHVKIT	1/10	32
1"	H-41414KIT	H-41414HVKIT	1/10	38	H-41414WKIT	H-41414WHVKIT	1/10	38
1 1/4"	H-41415KIT	H-41415HVKIT	1/10	49	H-41415WKIT	H-41415WHVKIT	1/10	52
<b>SWT × Rotating Flange</b>					600 PSI CWP Max			
3/4"	H-51413KIT	H-51413HVKIT	1/10	32	H-51413WKIT	H-51413WHVKIT	1/10	32
1"	H-51414KIT	H-51414HVKIT	1/10	38	H-51414WKIT	H-51414WHVKIT	1/10	38
1 1/4"	H-51415KIT	H-51415HVKIT	1/10	49	H-51415WKIT	H-51415WHVKIT	1/10	52
<b>Press × Rotating Flange</b>					250 PSI CWP Max			
3/4"	-	H-81413HVKIT	1/10	32	-	-	-	-
1"	-	H-81414HVKIT	1/10	39	-	-	-	-
1 1/4"	-	H-81415HVKIT	1/10	52	-	-	-	-

HV ITEMS FIT HIGH VELOCITY & STANDARD SIZE PUMPS. 2" ISOLATORS HAVE 1 1/2" PORT.



**DESIGNED FOR HIGH  
EFFICIENCY VARIABLE  
SPEED PUMPS**

# The ISOLATOR<sup>®</sup>

UNI-FLANGE BALL VALVE<sup>®</sup>  
with **ROUND FLANGE**

- Detachable rotating round flange
- Three flange styles compatible with a full range of popular pumps



## FLANGE DIMENSIONS

	A	B	C	D	E
RF375	5"	3 7/8"	2 11/16"	5/8"	5/8"
RF400	5 1/4"	4"	-	9/16"	-
RF475	6 1/8"	4 3/4"	4"	-	13/16"

### RF375 FLANGE

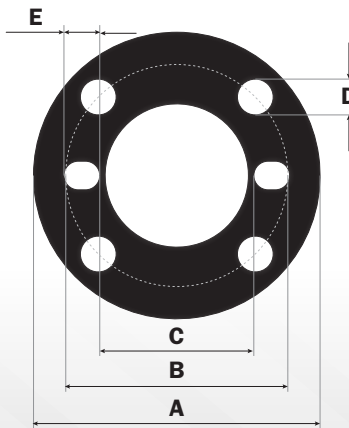

### RF400 FLANGE

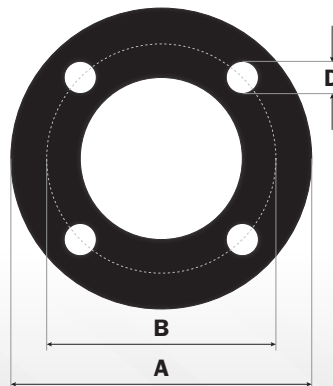

### RF475 FLANGE

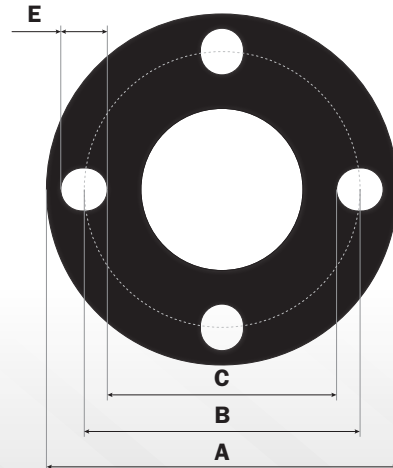

#### ISOLATOR W/ ROUND FLANGE

Full Port Forged Brass Uni-Flange Ball Valve w/ Detachable Rotating Flange, Adjustable Packing Gland, Nuts & Bolts

##### STANDARD BRASS

SIZE	HV ITEM#	CTN/CASE	CASE WT
<b>FIP × Rotating Flange</b>			600 PSI CWP Max
1 1/2"	H-41406HV-RF375	1/6	22
<b>SWT × Rotating Flange</b>			600 PSI CWP Max
1 1/2"	H-51406HV-RF375	1/6	22
<b>Press × Rotating Flange</b>			250 PSI CWP Max/250°F Max
1 1/2"	H-81406HV-RF375	1/6	23

##### W/ MULTI-FUNCTION HI-FLOW HOSE DRAIN

<b>FIP × Rotating Flange</b>			600 PSI CWP Max
1 1/2"	H-41416HV-RF375	1/6	26
<b>SWT × Rotating Flange</b>			600 PSI CWP Max
1 1/2"	H-51416HV-RF375	1/6	26
<b>Press × Rotating Flange</b>			250 PSI CWP Max/250°F Max
1 1/2"	H-81416HV-RF375	1/6	27

#### ISOLATOR W/ ROUND FLANGE

Full Port Forged Brass Uni-Flange Ball Valve w/ Detachable Rotating Flange, Adjustable Packing Gland, Nuts & Bolts

##### STANDARD BRASS

SIZE	HV ITEM#	CTN/CASE	CASE WT
<b>FIP × Rotating Flange</b>			600 PSI CWP Max
2"	H-41407HV-RF400	1/6	30
<b>SWT × Rotating Flange</b>			600 PSI CWP Max
2"	H-51407HV-RF400	1/6	32
<b>Press × Rotating Flange</b>			250 PSI CWP Max/250°F Max
2"	H-81407HV-RF400	1/6	33

##### W/ MULTI-FUNCTION HI-FLOW HOSE DRAIN

<b>FIP × Rotating Flange</b>			600 PSI CWP Max
2"	H-41417HV-RF400	1/6	37
<b>SWT × Rotating Flange</b>			600 PSI CWP Max
2"	H-51417HV-RF400	1/6	38
<b>Press × Rotating Flange</b>			250 PSI CWP Max/250°F Max
2"	H-81417HV-RF400	1/6	38

#### ISOLATOR W/ ROUND FLANGE

Full Port Forged Brass Uni-Flange Ball Valve w/ Detachable Rotating Flange, Adjustable Packing Gland, Nuts & Bolts

##### STANDARD BRASS

SIZE	HV ITEM#	CTN/CASE	CASE WT
<b>FIP × Rotating Flange</b>			600 PSI CWP Max
2"	H-41407HV-RF475	1/6	31
<b>SWT × Rotating Flange</b>			600 PSI CWP Max
2"	H-51407HV-RF475	1/6	33
<b>Press × Rotating Flange</b>			250 PSI CWP Max/250°F Max
2"	H-81407HV-RF475	1/6	34

##### W/ MULTI-FUNCTION HI-FLOW HOSE DRAIN

<b>FIP × Rotating Flange</b>			600 PSI CWP Max
2"	H-41417HV-RF475	1/6	38
<b>SWT × Rotating Flange</b>			600 PSI CWP Max
2"	H-51417HV-RF475	1/6	39
<b>Press × Rotating Flange</b>			250 PSI CWP Max/250°F Max
2"	H-81417HV-RF475	1/6	41



# The ISOLATOR<sup>®</sup>

UNI-FLANGE BALL VALVE<sup>®</sup>

## SELECT<sup>™</sup>

WITH 4-WAY SELECTABLE FLOW PATH

- Easily fill, purge, sample or add a pressure gauge right at the pump
- 1" side ports enable quicker filling and purging – ideal for Geothermal applications
- Easily direct fluid between 4 available ports
- Easily isolate the pump for replacement

**IDEAL FOR  
GEOHERMAL  
APPLICATIONS**



### 2-PUMP GEOTHERMAL SYSTEM OVERVIEW

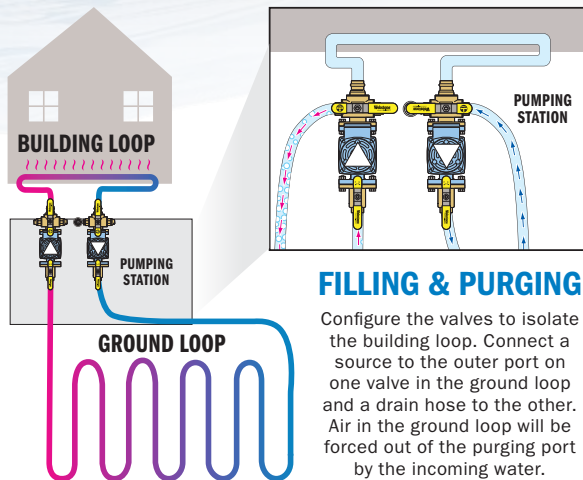

**ISOLATOR SELECT**  
Full Port Forged Brass Uni-Flange Ball Valve w/ 4-Way Selectable Flow Path, Plugged FNPT Ports, Adjustable Packing Glands, Nuts & Bolts, Flange Gasket

SIZE	HV ITEM#	CTN/CASE	CASE WT
1" FIP × Press × Rotating Flange	H-81424HV	1/10	35

FITS STANDARD & HIGH VELOCITY PUMPS

## DOUBLE FLANGED CHECK VALVE

The easiest way to add a check valve to any pump!  
Two sizes cover all standard Isolator installations.

- Installs between the pump & Isolator
- Limits SKUs and saves space on the truck!
- Outfitted with slotted bolt holes that fit both standard and high velocity pumps
- Replacement check assemblies available



### SNUG-FIT ROTATING FLANGE



SECTION REMOVED TO SHOW INTERNAL CONSTRUCTION

**ISOLATOR DOUBLE FLANGED CHECK**  
Forged Brass Check Valve w/ Rotating Flange - Includes One Set of Mounting Bolts & Flange Gasket

SIZE	HV ITEM#	CTN/CASE	CASE WT
Flange × Rotating Flange			150 PSI @ 200°F
3/4" thru 1 1/4"	H-13703HV	1/10	16
1 1/2" thru 2"	H-13706HV	1/10	18

FITS STANDARD & HIGH VELOCITY PUMPS



# PRO-CONNECT™ PP-R PRO™

## INNOVATIVE VALVES FOR AQUATHERM® PP-R PIPE

PATENTED TECHNOLOGY WITH FURTHER PATENTS PENDING

- Permanent leak-free heat fused connections made in seconds
- Compatible with all Aquatherm PP-R piping systems
- Safe, clean, long-lasting, high performance materials
- Suitable for potable applications
- Available in female metric socket nominal sizes 1/2" to 2"
- Saves labor, space & leak paths
- Available exclusively at Aquatherm dealers



**BALL VALVE**  
Full Port Forged Brass Ball Valve w/ Adjustable Packing Gland

**LEAD-FREE BRASS**  
Certified to NSF/ANSI 61 & 372

SIZE	SOCKET I.D.	ITEM#	CTN/CASE	CASE WT
<b>Female PP-R Metric Socket</b> 355 PSI*				
1/2"	20 mm	H-91702W	5/50	30
3/4"	25 mm	H-91703W	5/40	35
1"	32 mm	H-91704W	4/20	33
1 1/4"	40 mm	H-91705W	5/20	49
1 1/2"	50 mm	H-91706W	4/16	57
2"	63 mm	H-91707W	2/8	39
<b>Female PP-R Metric Socket x FIP</b> 355 PSI*				
1/2"	20 mm	H-94702W	5/50	28
3/4"	25 mm	H-94703W	5/40	33
1"	32 mm	H-94704W	4/20	29
1 1/4"	40 mm	H-94705W	5/20	43
1 1/2"	50 mm	H-94706W	4/16	50
2"	63 mm	H-94707W	2/8	34



**ISOLATOR W/ ROTATING FLANGE & MULTI-FUNCTION DRAIN**  
Full Port Forged Brass Uni-Flange Ball Valve w/ Detachable Rotating Flange, Multi-Function Hi-Flow Hose Drain, Adjustable Packing Glands, Nuts & Bolts

**LEAD-FREE BRASS**  
Certified to NSF/ANSI 61 & 372

SIZE	SOCKET I.D.	HV ITEM#	CTN/CASE	CASE WT
<b>Female PP-R Metric Socket x Rotating Flange</b> 355 PSI*				
3/4"	25 mm	H-91413WHV	1/20	36
1"	32 mm	H-91414WHV	1/20	45
1 1/4"	40 mm	H-91415WHV	1/10	32
1 1/2"	50 mm	H-91416WHV	1/10	40
2"	63 mm	H-91417WHV	1/10	43

FITS STANDARD & HIGH VELOCITY PUMPS - 2" ISOLATORS HAVE 1 1/2" PORT

### BALL DRAIN

Full Port Forged Brass Ball Valve w/ Hi-Flow Hose Drain, Reversible Handle & Adjustable Packing Glands

**LEAD-FREE BRASS**  
Certified to NSF/ANSI 61 & 372

SIZE	SOCKET I.D.	ITEM#	CTN/CASE	CASE WT
<b>Female PP-R Metric Socket</b> 355 PSI*				
3/4"	25 mm	H-90613W	4/32	39
1"	32 mm	H-90614W	2/20	40
1 1/4"	40 mm	H-90615W	2/16	47
1 1/2"	50 mm	H-90616W	1/8	33
2"	63 mm	H-90617W	1/6	35



**ISOLATOR W/ ROTATING FLANGE**  
Full Port Forged Brass Uni-Flange Ball Valve w/ Detachable Rotating Flange, Adjustable Packing Glands, Nuts & Bolts

**LEAD-FREE BRASS**  
Certified to NSF/ANSI 61 & 372

SIZE	SOCKET I.D.	HV ITEM#	CTN/CASE	CASE WT
<b>Female PP-R Metric Socket x Rotating Flange</b> 355 PSI*				
3/4"	25 mm	H-91403WHV	1/20	28
1"	32 mm	H-91404WHV	1/20	39
1 1/4"	40 mm	H-91405WHV	1/20	49
1 1/2"	50 mm	H-91406WHV	1/10	36
2"	63 mm	H-91407WHV	1/10	38

FITS STANDARD & HIGH VELOCITY PUMPS - 2" ISOLATORS HAVE 1 1/2" PORT

### STEM EXTENSION KIT

- Replaces existing handle
- Accommodates up to 2" of insulation
- Improves handle accessibility

#### STEM EXTENSION KIT

For Use with Series Valves

VALVE SIZE	ITEM#	CTN/CASE	CASE WT
<b>FITS BALL VALVE (9170 &amp; 9470 SERIES)</b>			
1/2" & 3/4"	H-SE-91702	12/48	23
1"	H-SE-91704	10/40	27
1 1/4"	H-SE-91705	8/32	24
1 1/2"	H-SE-91706	6/24	28
2"	H-SE-91707	6/24	28
<b>FITS ISOLATOR W/ ROTATING FLANGE (9140 SERIES) AND BALL DRAIN (9061 SERIES)</b>			
3/4"	H-SE-91702	12/48	23
1"	H-SE-91704	10/40	27
1 1/4"	H-SE-91705	8/32	24
1 1/2" & 2"	H-SE-91706	6/24	28
<b>FITS ISOLATOR W/ ROTATING FLANGE &amp; MULTI-FUNCTION DRAIN (9141 SERIES)</b>			
3/4"	H-SE-91413	12/48	24
1"	H-SE-91414	10/40	27
1 1/4"	H-SE-91415	8/32	24
1 1/2" & 2"	H-SE-91416	8/24	29



\*Overall valve pressure rating at 73° F. Further restrictions determined by intended operating conditions and limitations specific to the system design. Maximum pressure rating for seat & body alone is 600 PSI.



# PRO-CONNECT™ PP-R PRO INNOVATIVE VALVES FOR ANY PP-R PIPE

PATENTED TECHNOLOGY WITH FURTHER PATENTS PENDING

- Permanent leak-free heat fused connections made in seconds
- PP-RCT sockets compatible with all PP-R & PP-RCT piping systems†
- Safe, clean, long-lasting, high performance materials
- Suitable for potable applications
- Available in female metric socket nominal sizes 1/2" to 2"
- Saves labor, space & leak paths

The ISOLATOR™  
UNI-FLANGE BALL VALVE®



**ISOLATOR W/ ROTATING FLANGE & MULTI-FUNCTION DRAIN**  
Full Port Forged Brass Uni-Flange Ball Valve w/  
Detachable Rotating Flange, Multi-Function Hi-Flow Hose  
Drain, Adjustable Packing Glands, Nuts & Bolts

LEAD-FREE BRASS

Certified to NSF/ANSI 61 & 372

SIZE	SOCKET I.D.	HV ITEM#	CTN/CASE	CASE WT
<b>Female PP-RCT Metric Socket × Rotating Flange</b> 600 PSI*				
3/4"	25 mm	H-101413WHV	1/20	36
1"	32 mm	H-101414WHV	1/20	45
1 1/4"	40 mm	H-101415WHV	1/10	32
1 1/2"	50 mm	H-101416WHV	1/10	38
2"	63 mm	H-101417WHV	1/10	43

FITS STANDARD & HIGH VELOCITY PUMPS - 2" ISOLATORS HAVE 1 1/2" PORT

The ISOLATOR™  
UNI-FLANGE BALL VALVE®



**ISOLATOR W/ ROTATING FLANGE**  
Full Port Forged Brass Uni-Flange Ball Valve w/ Detachable  
Rotating Flange, Adjustable Packing Glands, Nuts & Bolts

LEAD-FREE BRASS

Certified to NSF/ANSI 61 & 372

SIZE	SOCKET I.D.	HV ITEM#	CTN/CASE	CASE WT
<b>Female PP-RCT Metric Socket × Rotating Flange</b> 600 PSI*				
3/4"	25 mm	H-101403WHV	1/20	29
1"	32 mm	H-101404WHV	1/20	39
1 1/4"	40 mm	H-101405WHV	1/20	54
1 1/2"	50 mm	H-101406WHV	1/10	36
2"	63 mm	H-101407WHV	1/10	38

FITS STANDARD & HIGH VELOCITY PUMPS - 2" ISOLATORS HAVE 1 1/2" PORT

## BALL VALVE

Full Port Forged Brass Ball Valve w/ Adjustable Packing Gland

LEAD-FREE BRASS

Certified to NSF/ANSI 61 & 372

SIZE	SOCKET I.D.	ITEM#	CTN/CASE	CASE WT
<b>Female PP-RCT Metric Socket</b> 600 PSI*				
1/2"	20 mm	H-101702W	5/50	31
3/4"	25 mm	H-101703W	5/40	36
1"	32 mm	H-101704W	4/20	33
1 1/4"	40 mm	H-101705W	5/20	49
1 1/2"	50 mm	H-101706W	4/16	57
2"	63 mm	H-101707W	2/8	40
<b>Female PP-RCT Metric Socket × FIP</b> 600 PSI*				
1/2"	20 mm	H-104702W	5/50	28
3/4"	25 mm	H-104703W	5/40	33
1"	32 mm	H-104704W	4/20	29
1 1/4"	40 mm	H-104705W	5/20	42
1 1/2"	50 mm	H-104706W	4/16	50
2"	63 mm	H-104707W	2/8	35



PRO-PAL  
SERIES

BALL DRAIN™



## BALL DRAIN

Full Port Forged Brass Ball Valve w/ Hi-Flow Hose Drain,  
Reversible Handle & Adjustable Packing Glands

LEAD-FREE BRASS

Certified to NSF/ANSI 61 & 372

SIZE	SOCKET I.D.	ITEM#	CTN/CASE	CASE WT
<b>Female PP-RCT Metric Socket</b> 600 PSI*				
3/4"	25 mm	H-100613W	4/32	39
1"	32 mm	H-100614W	2/20	40
1 1/4"	40 mm	H-100615W	2/16	47
1 1/2"	50 mm	H-100616W	1/8	33
2"	63 mm	H-100617W	1/6	35

## STEM EXTENSION KIT

- Replaces existing handle
- Accommodates up to 2" of insulation
- Improves handle accessibility



## STEM EXTENSION KIT

For Use with Series Valves

VALVE SIZE	ITEM#	CTN/CASE	CASE WT
<b>FITS BALL VALVE (10170 &amp; 10470 SERIES)</b>			
1/2" & 3/4"	H-SE-91702	12/48	23
1"	H-SE-91704	10/40	27
1 1/4"	H-SE-91705	8/32	24
1 1/2"	H-SE-91706	6/24	28
2"	H-SE-91707	6/24	28

**FITS ISOLATOR W/ ROTATING FLANGE (10140 SERIES)  
AND BALL DRAIN (10061 SERIES)**

3/4"	H-SE-91702	12/48	23
1"	H-SE-91704	10/40	27
1 1/4"	H-SE-91705	8/32	24
1 1/2" & 2"	H-SE-91706	6/24	28

**FITS ISOLATOR W/ ROTATING FLANGE &  
MULTI-FUNCTION DRAIN (10141 SERIES)**

3/4"	H-SE-91413	12/48	24
1"	H-SE-91414	10/40	27
1 1/4"	H-SE-91415	8/32	24
1 1/2" & 2"	H-SE-91416	8/24	29

†In accordance with piping manufacturer's installation and warranty requirements.  
\*Valve seat/body maximum pressure rating at 100° F. Overall valve pressure rating is determined by intended operating conditions and limitations specific to the system design.



# PRO-CONNECT PRO PUSH™

# PRO PERFORMANCE PUSH CONVENIENCE

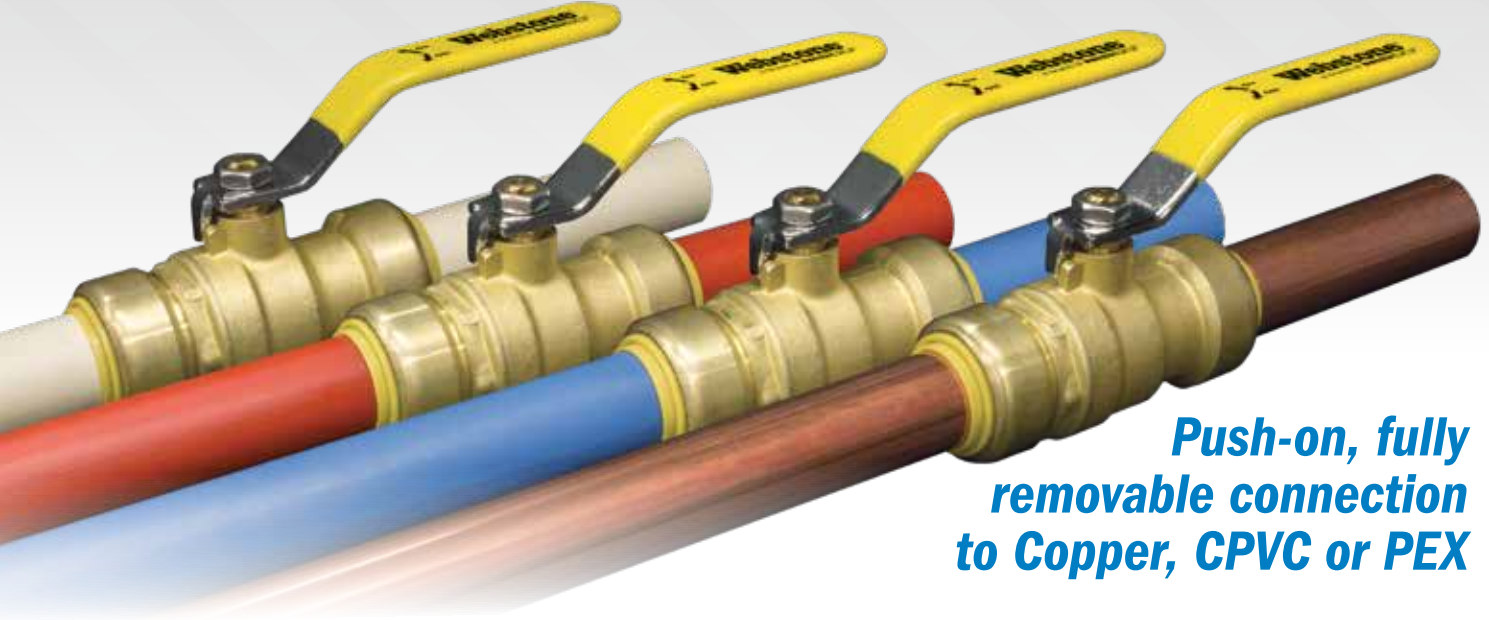

*Push-on, fully removable connection to Copper, CPVC or PEX*



### PROPUSH BALL VALVE

Full Port Forged DZR Brass w/ Adjustable Packing Gland · For Connection to Copper, CPVC, or PEX

#### LEAD-FREE BRASS

Certified to NSF/ANSI 61 & 372, NSF/ANSI 14, ASSE 1061

SIZE	ITEM#	CTN/CASE	CASE WT
Push		200 PSI CWP Max/200°F Max	
1/2"	H-62702W	10/100	44
3/4"	H-62703W	10/100	63
1"	H-62704W	5/50	56



### PROPUSH 90 DEGREE ELBOW

Forged DZR Brass Fitting · For Connection to Copper, CPVC or PEX

#### LEAD-FREE BRASS

Certified to NSF/ANSI 61 & 372, ASSE 1061

SIZE	ITEM#	CTN/CASE	CASE WT
Push		200 PSI CWP Max/200°F Max	
1/4"	H-26400W-B	6/360	26
1/2"	H-26402W	20/200	31
1/2" x 3/8"	H-26421W-B	12/180	28
3/4"	H-26403W	12/120	33
3/4" x 1/2"	H-26432W	12/120	25
1"	H-26404W	10/100	48
1" x 3/4"	H-26443W-B	3/60	24
Push x FIP		200 PSI CWP Max/200°F Max	
1/2"	H-26422W	20/200	31
Push x MIP		200 PSI CWP Max/200°F Max	
1/2"	H-26222W	20/200	31
3/4"	H-26233W-B	6/90	27

### PROPUSH STRAIGHT COUPLING

Forged DZR Brass Fitting · For Connection to Copper, CPVC or PEX

#### LEAD-FREE BRASS

Certified to NSF/ANSI 61 & 372, ASSE 1061

SIZE	ITEM#	CTN/CASE	CASE WT
Push		200 PSI CWP Max/200°F Max	
1/4"	H-26100W-B	6/600	33
1/4" x 1/2"	H-26120W-B	6/150	15
3/8"	H-26101W	25/250	24
3/8" x 1/2"	H-26112W	25/250	29
1/2"	H-26102W	25/250	31
3/4"	H-26103W	10/100	21
3/4" x 1/2"	H-26132W	15/150	27
1"	H-26104W	9/90	29
1" x 3/4"	H-26143W	9/90	24
1 1/4"	H-26105W-B	1/30	26
1 1/4" x 1"	H-26154W-B	1/30	19
1 1/2"	H-26106W-B	1/27	39
1 1/2" x 1 1/4"	H-26165W-B	1/20	23
2"	H-26107W-B	1/20	38
2" x 1 1/2"	H-26176W-B	1/15	26
Push x FIP		200 PSI CWP Max/200°F Max	
1/4" x 1/2"	H-26220W-B	6/180	21
3/8" x 1/2"	H-26212W-B	6/180	20
1/2"	H-26202W	20/200	25
1/2" x 3/4"	H-26223W	20/200	33
3/4"	H-26203W	12/120	25
3/4" x 1/2"	H-26232W-B	6/180	24
3/4" x 1"	H-26234W-B	6/90	23
1"	H-26204W	9/90	25
Push x MIP		200 PSI CWP Max/200°F Max	
1/4" x 1/2"	H-26320W-B	6/180	19
1/2"	H-26302W	20/200	23
1/2" x 3/4"	H-26323W	20/200	35
3/4"	H-26303W	15/150	28
3/4" x 1/2"	H-26332W-B	6/150	21
3/4" x 1"	H-26334W-B	6/90	25
1"	H-26304W	9/90	24
1" x 3/4"	H-26343W	9/90	22

### PROPUSH TEE

Forged DZR Brass Fitting · For Connection to Copper, CPVC or PEX

#### LEAD-FREE BRASS

Certified to NSF/ANSI 61 & 372, ASSE 1061

SIZE	ITEM#	CTN/CASE	CASE WT
Push		200 PSI CWP Max/200°F Max	
1/4"	H-26500W-B	6/300	22
3/8"	H-26501W-B	6/150	26
3/8" x 3/8" x 1/2"	H-26512W-B	6/120	22
1/2"	H-26502W	12/120	25
1/2" x 1/2" x 1/4"	H-26520W-B	6/120	22
1/2" x 1/2" x 3/8"	H-26521W-B	6/120	25
3/4"	H-26503W	12/120	43
3/4" x 1/2" x 1/2"	H-26522W	18/180	44
3/4" x 3/4" x 1/2"	H-26532W	15/150	48
3/4" x 1/2" x 3/4"	H-26533W	12/120	39
1"	H-26504W	6/60	38
1" x 1" x 3/4"	H-26543W	6/60	30



**PROPUSH FLEXIBLE WATER HEATER CONNECTOR**  
Braided Stainless Steel - For Connection to Copper, CPVC or PEX

**LEAD-FREE BRASS**

Certified to NSF/ANSI 61-G, ASSE 1061, ASME A112.18.6, CSA B125.6

SIZE	LENGTH	ITEM#	CTN/CASE	CASE WT
<b>Push × FIP</b> 200 PSI CWP Max/200°F Max				
1/2" × 3/4"	12"	H-26023W-12-B	12/60	18
3/4"	12"	H-26033W-12	1/50	31
1/2" × 3/4"	15"	H-26023W-15-B	12/60	20
3/4"	15"	H-26033W-15	1/50	33
1/2" × 3/4"	18"	H-26023W-18	1/50	21
3/4"	18"	H-26033W-18	1/50	41
1/2" × 3/4"	24"	H-26023W-24-B	12/60	25
3/4"	24"	H-26033W-24	1/50	44

**W/ FULL PORT FORGED DZR BRASS BALL VALVE**

1/2" × 3/4"	18"	H-62023W-18	1/25	19
3/4"	18"	H-62033W-18	1/25	31

**ALSO AVAILABLE W/PUSH CONNECTIONS**



TWH SERVICE VALVES  
**EXPE2** SEE PAGE 12  
SPACE SAVING

**THERMOSTATIC MIXING VALVE**  
SEE PAGE 4

**UNION BALL**  
SEE PAGE 30

**PROPUSH IN-LINE SPRING CHECK VALVE**

Forged DZR Brass Fitting - For Connection to Copper, CPVC or PEX

**LEAD-FREE BRASS**

Certified to NSF/ANSI 61 & 372, ASSE 1061

SIZE	ITEM#	CTN/CASE	CASE WT
<b>Push</b> 200 PSI CWP Max/200°F Max			
1/2"	H-26992W-B	6/120	20
3/4"	H-26993W-B	12/120	39
1"	H-26994W-B	3/45	25



**PROPUSH 90 DEGREE DROP EAR ELBOW**

Forged DZR Brass Fitting - For Connection to Copper, CPVC or PEX

**LEAD-FREE BRASS**

Certified to NSF/ANSI 61 & 372, ASSE 1061

SIZE	ITEM#	CTN/CASE	CASE WT
<b>Push × FIP</b> 200 PSI CWP Max/200°F Max			
1/2"	H-26412W	9/90	21
3/4"	H-26413W-B	6/90	33
<b>Push</b> 200 PSI CWP Max/200°F Max			
1/2"	H-26462W	9/90	21



**PROPUSH 1/4 TURN SUPPLY STOP**

Chrome-Plated DZR Brass - For Connection to Copper, CPVC or PEX

**LEAD-FREE BRASS**

Certified to NSF/ANSI 61 & 372, ASSE 1061, ASME A112.18.6, CSA B125.6

SIZE	ITEM#	CTN/CASE	CASE WT
<b>ANGLED</b>			
<b>Push × Compression</b>			
1/2" × 1/4"	H-26820W	20/200	53
1/2" × 3/8"	H-26821W	20/200	53
<b>STRAIGHT</b>			
<b>Push × Compression</b>			
1/2" × 1/4"	H-26920W	20/200	49
1/2" × 3/8"	H-26921W	20/200	49



**PROPUSH 90 DEGREE HY-EAR ELBOW**

Forged DZR Brass Fitting - For Connection to Copper, CPVC or PEX

**LEAD-FREE BRASS**

Certified to NSF/ANSI 61 & 372, ASSE 1061

SIZE	ITEM#	CTN/CASE	CASE WT
<b>Push × FIP</b> 200 PSI CWP Max/200°F Max			
1/2"	H-26412WHE-B	6/120	32



**PROPUSH REPAIR TEE**

Forged DZR Brass Fitting - For Connection to Copper, CPVC or PEX

**LEAD-FREE BRASS**

Certified to NSF/ANSI 61 & 372, ASSE 1061

SIZE	ITEM#	CTN/CASE	CASE WT
<b>Push</b> 200 PSI CWP Max/200°F Max			
1/2"	H-26702W	8/80	26
3/4"	H-26703W	6/60	32

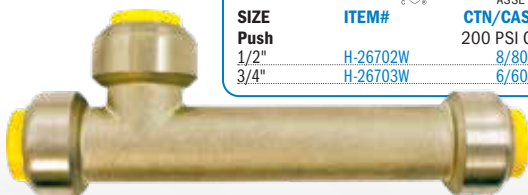

**PROPUSH SLIP COUPLING**

Forged DZR Brass Fitting - For Connection to Copper, CPVC or PEX

**LEAD-FREE BRASS**

Certified to NSF/ANSI 61 & 372, ASSE 1061

SIZE	ITEM#	CTN/CASE	CASE WT
<b>Push</b> 200 PSI CWP Max/200°F Max			
1/2"	H-26122W	15/150	34
3/4"	H-26133W	5/50	19
1"	H-26144W	5/50	27



**PROPUSH END CAP**

Forged DZR Brass Fitting - For Connection to Copper, CPVC or PEX

**LEAD-FREE BRASS**

Certified to NSF/ANSI 61 & 372, ASSE 1061

SIZE	ITEM#	CTN/CASE	CASE WT
<b>Push</b> 200 PSI CWP Max/200°F Max			
3/8"	H-26601W-B	6/300	21
1/2"	H-26602W	30/300	22
3/4"	H-26603W	20/200	23
1"	H-26604W	12/120	24

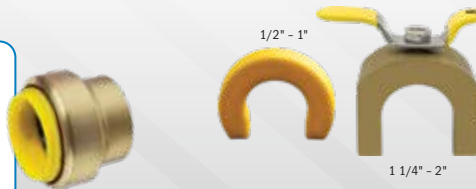

1/2" - 1"

1 1/4" - 2"

**PROPUSH REMOVAL TOOL**

SIZE	ITEM#	CTN/CASE	CASE WT
1/4"	H-28110-B	24/1200	10
3/8"	H-28111-B	24/1200	9
1/2"	H-28112	1/300	3
3/4"	H-28113	1/300	5
1"	H-28114	1/250	6
1 1/4"	H-28115-B	1/50	1
1 1/2"	H-28116-B	1/50	1
2"	H-28117-B	1/50	1



**PROPUSH DEBURR & GAUGE TOOL**

SIZE	ITEM#	BAG/CASE	CASE WT
1/4" - 1"	H-28000-B	1/50	7



**PROPUSH PEX ADAPTER SET**

SIZE	ITEM#	CTN/CASE	CASE WT
1/2"	H-28212	1/300	1
3/4"	H-28213	1/300	1
1"	H-28214	1/250	4
1 1/4"	H-28215-B	1/100	5
1 1/2"	H-28216-B	1/100	8
2"	H-28217-B	1/100	13



1 1/4" - 2"



# TRANSITION FITTINGS

PATENTS PENDING

- Lead-free brass construction
- Eliminate multiple fittings and adapters
- Save space and eliminate leak paths
- Press connections compatible with popular press tools
- PEX connections available with F1960 Cold Expansion or F1807 Crimp/Clamp connections

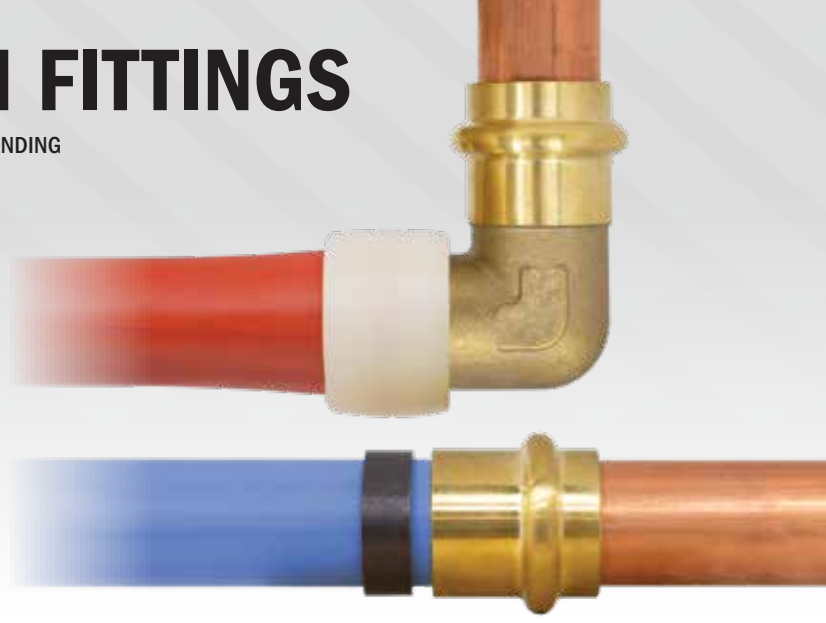

**FORGED DZR BRASS 90° TRANSITION ELBOW**

**LEAD-FREE BRASS**  
Certified to NSF/ANSI 61 & 372, NSF/ANSI 14 - IGC 319, PS117

SIZE	ITEM#	CTN/CASE	CASE WT
<b>Press × F1960 PEX</b> 250 PSI CWP Max/250°F Max			
1/2"	H-36842W	32/128	21
3/4"	H-36843W	32/128	35
3/4" × 1/2"	H-36843W-R	32/128	22
3/4" × 5/8"	H-36843W-R58	32/128	31
3/4" × 1"	H-36844W-RX	32/128	36
1"	H-36844W	32/128	63
1" × 3/4"	H-36844W-R	32/128	41
1 1/4"	H-36845W	18/54	40
1 1/2"	H-36846W	18/54	50
2"	H-36847W	8/16	28
<b>Press × F1807 PEX</b> 250 PSI CWP Max/250°F Max			
1/2"	H-16842W	32/128	14
3/4"	H-16843W	32/128	25
3/4" × 1/2"	H-16843W-R	32/128	21
3/4" × 5/8"	H-16843W-R58	32/128	26
3/4" × 1"	H-16844W-RX	32/128	26
1"	H-16844W	32/128	45
1" × 3/4"	H-16844W-R	32/128	39
1 1/4"	H-16845W	18/54	36
1 1/2"	H-16846W	18/54	49
2"	H-16847W	8/16	27



**FORGED DZR BRASS TRANSITION FITTING**

**LEAD-FREE BRASS**  
Certified to NSF/ANSI 61 & 372, NSF/ANSI 14 - IGC 319, PS117

SIZE	ITEM#	CTN/CASE	CASE WT
<b>Press × F1960 PEX</b> 250 PSI CWP Max/250°F Max			
1/2"	H-36802W	30/120	10
3/4"	H-36803W	30/120	17
3/4" × 1/2"	H-36803W-R	30/120	16
3/4" × 5/8"	H-36803W-R58	30/120	18
3/4" × 1"	H-36804W-RX	30/120	26
1"	H-36804W	30/120	27
1" × 3/4"	H-36804W-R	30/120	23
1 1/4"	H-36805W	20/80	29
1 1/2"	H-36806W	20/80	46
2"	H-36807W	9/27	29
<b>Press × F1807 PEX</b> 250 PSI CWP Max/250°F Max			
1/2"	H-16802W	30/120	8
3/4"	H-16803W	30/120	14
3/4" × 1/2"	H-16803W-R	30/120	14
3/4" × 5/8"	H-16803W-R58	30/120	16
3/4" × 1"	H-16804W-RX	30/120	17
1"	H-16804W	30/120	20
1" × 3/4"	H-16804W-R	30/120	20
1 1/4"	H-16805W	20/80	21
1 1/2"	H-16806W	20/80	67
2"	H-16807W	9/27	46



**FORGED DZR BRASS TRANSITION TEE**

**LEAD-FREE BRASS**  
Certified to NSF/ANSI 61 & 372, NSF/ANSI 14 - IGC 319, PS117

SIZE	ITEM#	CTN/CASE	CASE WT
<b>Press × Press × F1960 PEX</b> 250 PSI CWP Max/250°F Max			
1/2"	H-86352W	25/100	18
3/4"	H-86353W	20/80	27
3/4" × 3/4 × 1/2"	H-86353W-R	20/80	22
1"	H-86354W	20/80	45
1" × 1 × 3/4"	H-86354W-R	20/80	37
1 1/4"	H-86355W	4/16	16
1 1/2"	H-86356W	2/8	11
2"	H-86357W	2/8	24
<b>Press × Press × F1807 PEX</b> 250 PSI CWP Max/250°F Max			
1/2"	H-86152W	25/100	17
3/4"	H-86153W	20/80	25
3/4" × 3/4 × 1/2"	H-86153W-R	20/80	21
1"	H-86154W	20/80	40
1" × 1 × 3/4"	H-86154W-R	20/80	35
1 1/4"	H-86155W	4/16	15



## PRESS × PRESS × FIP TRANSITION TEE

- Ideal for branch or device connections in tight locations

**FORGED DZR BRASS TRANSITION TEE**

**LEAD-FREE BRASS**  
Certified to NSF/ANSI 61 & 372, NSF/ANSI 14 - IGC 319, PS117

SIZE	ITEM#	CTN/CASE	CASE WT
<b>F1960 PEX × F1960 PEX × Press</b> 250 PSI CWP Max/250°F Max			
1/2"	H-36852W	25/100	21
1/2" × 1/2 × 3/4"	H-36852W-BH	20/80	21
3/4"	H-36853W	20/80	29
3/4" × 3/4 × 1"	H-36853W-BH	16/64	29
1"	H-36854W	20/80	49
1 1/4"	H-36855W	6/24	28
1 1/2"	H-36856W	2/8	12
2"	H-36857W	2/8	29
<b>F1807 PEX × F1807 PEX × Press</b> 250 PSI CWP Max/250°F Max			
1/2"	H-16852W	25/100	18
1/2" × 1/2 × 3/4"	H-16852W-BH	20/80	20
3/4"	H-16853W	20/80	26
3/4" × 3/4 × 1"	H-16853W-BH	16/64	27
1"	H-16854W	20/80	42
1 1/4"	H-16855W	6/24	21



**FORGED DZR BRASS TRANSITION TEE**

**LEAD-FREE BRASS**  
Certified to NSF/ANSI 61 & 372

SIZE	ITEM#	CTN/CASE	CASE WT
<b>Press × Press × FIP</b> 250 PSI CWP Max/250°F Max			
1/2"	H-86452W	20/80	19
1/2" × 1/2 × 1/4"	H-86452W-R	25/100	18
3/4"	H-86453W	20/80	32
3/4" × 3/4 × 1/4"	H-86453W-R14	20/80	21
3/4" × 3/4 × 1/2"	H-86453W-R	20/80	27
1" × 1/2"	H-86454W-R12	20/80	38





# TRANSITION FITTINGS

PATENTS PENDING

## DUAL VENT TRANSITION ELBOW

- For use with the 1/8" NPT vent of your choice
- Includes stiffener for copper finned tube press connections
- Ideal for baseboards and boiler risers

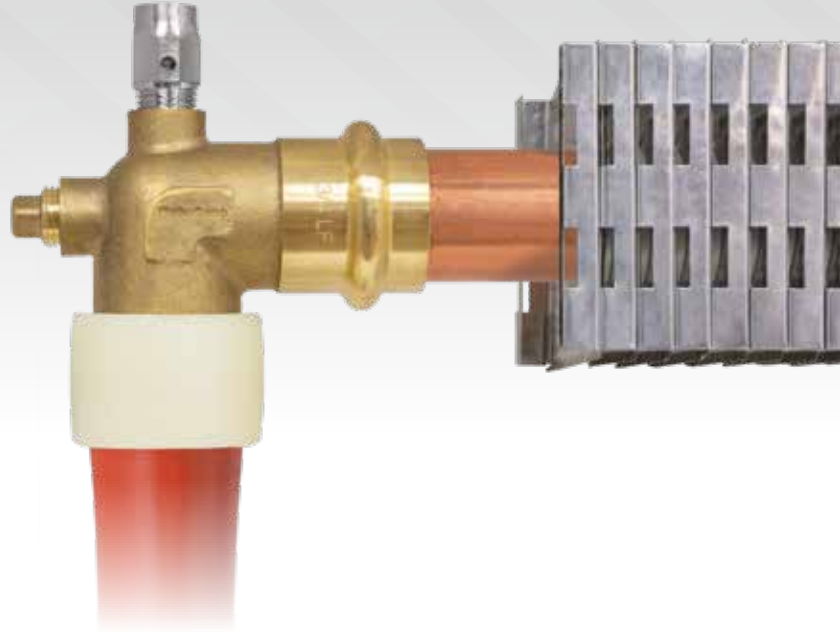

**FORGED DZR BRASS DUAL VENT TRANSITION ELBOW**  
w/ 3/4" Copper Finned Tube Stiffener & 1/8" NPT Plug

### LEAD-FREE BRASS

Certified to NSF/ANSI 61 & 372, NSF/ANSI 14 - IGC 319, PS117. Applies to elbow & plug

SIZE	ITEM#	CTN/CASE	CASE WT
<b>Press × F1960 PEX</b> 250 PSI CWP Max/250°F Max			
3/4"	H-36833W	32/128	36
3/4" × 1/2"	H-36833W-R	32/128	30
3/4" × 5/8"	H-36833W-R58	32/128	38
<b>Press × F1807 PEX</b> 250 PSI CWP Max/250°F Max			
3/4"	H-16833W	32/128	31
3/4" × 1/2"	H-16833W-R	32/128	27
3/4" × 5/8"	H-16833W-R58	32/128	33

**FORGED DZR BRASS TRANSITION ELBOW**  
w/ 3/4" Copper Finned Tube Stiffener

### LEAD-FREE BRASS

Certified to NSF/ANSI 61 & 372, NSF/ANSI 14 - IGC 319, PS117. Applies to elbow H-3684xW

SIZE	ITEM#	CTN/CASE	CASE WT
<b>Press × F1960 PEX</b> 250 PSI CWP Max/250°F Max			
3/4"	H-36823W	32/128	35
3/4" × 1/2"	H-36823W-R	32/128	21
3/4" × 5/8"	H-36823W-R58	32/128	35
3/4" × 1"	H-36824W-RX	32/128	40
<b>Press × F1807 PEX</b> 250 PSI CWP Max/250°F Max			
3/4"	H-16823W	32/128	25
3/4" × 1/2"	H-16823W-R	32/128	22
3/4" × 5/8"	H-16823W-R58	32/128	30
3/4" × 1"	H-16824W-RX	32/128	30

## PRESS STIFFENER

- Required for making copper finned tube press connections



### BRASS STIFFENER

For use with Copper Finned Tube

#### LEAD-FREE BRASS

SIZE	ITEM#	CTN/CASE	CASE WT
3/4"	H-28303W	100/400	13

# UNIONS



**FORGED DZR BRASS UNION**

### LEAD-FREE BRASS

Certified to NSF/ANSI 61 & 372, NSF/ANSI 14 - IGC 319, PS117

SIZE	ITEM#	CTN/CASE	CASE WT
<b>Press × F1960 PEX Union</b> 250 PSI CWP Max/180°F Max			
1/2"	H-38102W	30/120	43
3/4"	H-38103W	30/120	64
1"	H-38104W	24/48	36
<b>Press × F1807 PEX Union</b> 250 PSI CWP Max/180°F Max			
1/2"	H-18102W	30/120	42
3/4"	H-18103W	30/120	60
1"	H-18104W	24/48	33



### DIELECTRIC UNION

Galvanized Steel & Forged DZR Brass w/ Nylon Insulator Ring

#### LEAD-FREE BRASS

Certified to NSF/ANSI 61 & 372 - PS117

SIZE	ITEM#	CTN/CASE	CASE WT
<b>FIP × Press Union</b> 250 PSI CWP Max/180°F Max			
1/2"	H-81102W	30/120	51
3/4"	H-81103W	30/120	75
1"	H-81104W	24/48	41

### DIELECTRIC UNION

Galvanized Steel & Brass - w/ Nylon Insulator Ring

#### LEAD-FREE BRASS

SIZE	ITEM#	CTN/CASE	CASE WT
<b>FIP × SWT</b> 232°F Max			
1/2"	H-01102W	24/144	46
3/4"	H-01103W	24/96	39
1"	H-01104W	12/96	53
1 1/4"	H-01105W	6/48	42
1 1/2"	H-01106W	6/36	50
2"	H-01107W	6/18	45
3/4" × 1/2"	H-01132W	24/96	37



# BALL VALVES

## FULL PORT FORGED BRASS BALL VALVE w/ Adjustable Packing Gland

### STANDARD BRASS

 Certified to NSF/ANSI 9.1

SIZE FIP	ITEM#	CTN/CASE	CASE WT
1/4"	H-41700	10/100	27
3/8"	H-41701	10/100	29
1/2"	H-41702	10/80	32
3/4"	H-41703	10/60	35
1"	H-41704	6/36	39
1 1/4"	H-41705	6/24	35
1 1/2"	H-41706	2/16	36
2"	H-41707	2/12	38

### LEAD-FREE BRASS

 Certified to NSF/ANSI 61 - ANSI Z21.15/CSA 9.1

ITEM#	CTN/CASE	CASE WT
H-41700W	10/100	27
H-41701W	10/100	29
H-41702W	10/80	31
H-41703W	10/60	35
H-41704W	6/36	38
H-41705W	6/24	35
H-41706W	2/16	36
H-41707W	2/12	38



AVAILABLE W/  
**PRO-CONNECT PRO-PUSH**  
FOR CONNECTION TO COPPER, CPVC, OR PEX  
SEE PAGE 42

### STANDARD BRASS

NSF/ANSI 61-8

SIZE SWT	ITEM#	CTN/CASE	CASE WT
1/2"	H-51702	10/80	27
3/4"	H-51703	10/60	33
1"	H-51704	6/36	35
1 1/4"	H-51705	6/24	33
1 1/2"	H-51706	2/16	36
2"	H-51707	2/12	38

### LEAD-FREE BRASS

Certified to NSF/ANSI 61, NSF/ANSI 61-8

ITEM#	CTN/CASE	CASE WT
H-51702W	10/80	26
H-51703W	10/60	33
H-51704W	6/36	35
H-51705W	6/24	32
H-51706W	2/16	41
H-51707W	2/12	38



AVAILABLE W/  
**PRO-CONNECT PRO-PPR**  
EXCLUSIVELY FOR  
**aquatherm**  
SEE PAGE 40

### STANDARD BRASS

Certified to NSF/ANSI 61

SIZE Press	ITEM#	CTN/CASE	CASE WT
1/2"	H-81702	5/50	27
3/4"	H-81703	5/40	33
1"	H-81704	4/20	27
1 1/4"	H-81705	5/20	39
1 1/2"	H-81706	4/16	41
2"	H-81707	2/8	33
2 1/2"	-	-	-
3"	-	-	-
4"	-	-	-

### LEAD-FREE BRASS

Certified to NSF/ANSI 61 & 372

ITEM#	CTN/CASE	CASE WT
H-81702W	5/50	26
H-81703W	5/40	32
H-81704W	4/20	24
H-81705W	5/20	38
H-81706W	4/16	43
H-81707W	2/8	33
H-81708W	1/1	9
H-81709W	1/1	12
H-81710W	1/1	21



AVAILABLE W/  
**PRO-CONNECT PRO-PPR**  
FOR ANY PP-R OR PP-RCT PIPING SYSTEM  
SEE PAGE 41

## FULL FLOW FORGED DZR BRASS BALL VALVE w/ Stainless Steel Wing Style "T" Handle & Adjustable Packing Gland

### LEAD-FREE BRASS

 Certified to NSF/ANSI 61 & 372, NSF/ANSI 14

SIZE	ITEM#	CTN/CASE	CASE WT
<b>F1960 PEX</b> 400 PSI CWP Max/250°F Max			
1/2"	H-31702WSSW	10/80	27
3/4"	H-31703WSSW	10/60	30
1"	H-31704WSSW	6/36	33
1 1/4"	H-31705WSSW	5/25	33
1 1/2"	H-31706WSSW	5/25	49
2"	H-31707WSSW	2/12	38
<b>F1807 PEX</b> 400 PSI CWP Max/250°F Max			
1/2"	H-11702WSSW	10/80	23
3/4"	H-11703WSSW	10/60	26
1"	H-11704WSSW	6/36	26



## FULL PORT FORGED BRASS BALL VALVE w/ 304 Stainless Steel Wing Style "T" Handle & Adjustable Packing Gland

### LEAD-FREE BRASS

 Certified to NSF/ANSI 61 - ANSI Z21.15/CSA 9.1 (Applies to base model H-4170xW)

SIZE FIP	ITEM#	CTN/CASE	CASE WT
1/2"	H-41702WSSW	10/80	39
3/4"	H-41703WSSW	10/60	36
1"	H-41704WSSW	6/36	39



## FORGED BRASS BALL VALVE & Adjustable Packing Gland

### LEAD-FREE BRASS

 Certified to NSF/ANSI 61-G

SIZE Compression	ITEM#	CTN/CASE	CASE WT
1/2"	H-40632W	25/100	56
3/4"	H-40633W	15/60	51
1"	H-40634W	10/40	52

## FULL PORT 316 STAINLESS STEEL BALL VALVE 2-Piece Investment Cast w/ 304 Stainless Steel Locking Handle & Adjustable Packing Gland

SIZE FIP	ITEM#	CTN/CASE	CASE WT
1000 PSI CWP MAX/150 WSP			
1/4"	H-43720	2/80	43
3/8"	H-43721	2/80	39
1/2"	H-43722	2/60	45
3/4"	H-43723	2/40	45
1"	H-43724	2/40	68
1 1/4"	H-43725	2/30	80
1 1/2"	H-43726	2/16	64
2"	H-43727	2/10	52

### W/ 304 STAINLESS STEEL OVAL HANDLE

1/2"	H-43722-0H	1/40	35
3/4"	H-43723-0H	1/30	37
1"	H-43724-0H	1/20	37

## FULL PORT NICKEL-PLATED FORGED BRASS BALL VALVE

w/ 304 Stainless Steel Lever Handle & Adjustable Packing Gland

### LEAD-FREE BRASS

 Certified to NSF/ANSI 61-G

SIZE FIP	ITEM#	CTN/CASE	CASE WT
600 PSI CWP MAX/150 WSP			
1/4"	H-40800W	20/120	43
3/8"	H-40801W	20/120	37
1/2"	H-40802W	20/120	54
3/4"	H-40803W	14/84	56
1"	H-40804W	8/48	53
1 1/4"	H-40805W	6/36	57
1 1/2"	H-40806W	4/24	59
2"	H-40807W	2/16	56





# TRANSITION BALL VALVES



**FULL PORT FORGED DZR BRASS BALL VALVE**  
w/ Adjustable Packing Gland

LEAD-FREE BRASS			
Certified to NSF/ANSI 61 & 372, NSF/ANSI 14			
SIZE	ITEM#	CTN/CASE	CASE WT
<b>Press × F1960 PEX</b> 250 PSI CWP Max/250°F Max			
1/2"	H-80332W	5/50	26
3/4"	H-80333W	5/40	21
1"	H-80334W	4/20	11
1 1/4"	H-80335W	5/20	46
1 1/2"	H-80336W	4/16	44
2"	H-80337W	2/8	40
<b>Press × F1807 PEX</b> 250 PSI CWP Max/250°F Max			
1/2"	H-80132W	5/50	26
3/4"	H-80133W	5/40	21
1"	H-80134W	4/20	11
1 1/4"	H-80135W	5/20	44
1 1/2"	H-80136W	4/16	42
2"	H-80137W	2/8	36

**FULL FLOW FORGED DZR BRASS BALL VALVE**  
w/ Stainless Steel Wing Style "T" Handle  
& Adjustable Packing Gland

LEAD-FREE BRASS			
Certified to NSF/ANSI 61 & 372, NSF/ANSI 14			
SIZE	ITEM#	CTN/CASE	CASE WT
<b>F1960 PEX × FIP</b> 400 PSI CWP Max/250°F Max			
1/2"	H-34702WSSW	10/80	29
3/4"	H-34703WSSW	10/60	32
1"	H-34704WSSW	6/36	32
<b>F1807 PEX × FIP</b> 400 PSI CWP Max/250°F Max			
1/2"	H-14702WSSW	10/80	26
3/4"	H-14703WSSW	10/60	29
1"	H-14704WSSW	6/36	29

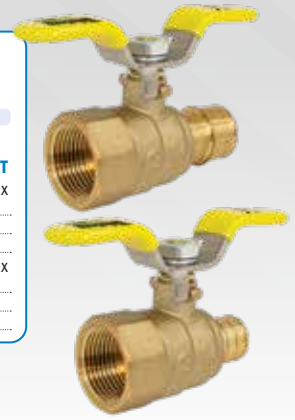

**FULL PORT FORGED BRASS BALL VALVE**  
w/ Reversible Handle & Adjustable Packing Gland

LEAD-FREE BRASS			
SIZE	ITEM#	CTN/CASE	CASE WT
<b>MIP × FIP</b> 600 PSI CWP Max/150 WSP			
1/4"	H-40530W	12/96	35
3/8"	H-40531W	12/96	33
1/2"	H-40532W	12/96	45
3/4"	H-40533W	10/60	44
1"	H-40534W	6/48	55

**FULL PORT FORGED BRASS BALL VALVE**  
Pet Cock Style

STANDARD BRASS			
SIZE	ITEM#	CTN/CASE	CASE WT
<b>FIP × MIP</b> 600 PSI CWP MAX/125 WSP			
1/8"	H-41685	10/100	19
1/4" × 1/8"	H-41686	10/100	10
1/4"	H-41687	10/100	18
<b>FIP</b> 600 PSI CWP Max/125 WSP			
1/8"	H-41698	10/100	18
1/4"	H-41699	10/100	17



**FULL FLOW FORGED BRASS BALL VALVE**  
w/ Wing Handle

STANDARD BRASS			
SIZE	ITEM#	CTN/CASE	CASE WT
<b>F1807 PEX × SWT</b> 160 PSI CWP MAX			
1/2"	H-50682	10/100	25

# SPECIALTY BALL VALVES

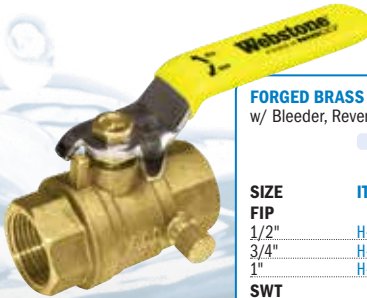

**FORGED BRASS BALL VALVE**  
w/ Bleeder, Reversible Handle & Adjustable Packing Gland

LEAD-FREE BRASS			
Certified to NSF/ANSI 61-G			
SIZE	ITEM#	CTN/CASE	CASE WT
<b>FIP</b> 600 PSI CWP MAX/150 WSP			
1/2"	H-40622W	15/120	60
3/4"	H-40623W	12/48	36
1"	H-40624W	8/32	38
<b>SWT</b> 600 PSI CWP Max/150 WSP			
1/2"	H-50622W	25/100	49
3/4"	H-50623W	10/40	31
1"	H-50624W	6/24	29

**FORGED BRASS GAS BALL VALVE**

STANDARD BRASS			
SIZE	ITEM#	CTN/CASE	CASE WT
<b>FIP</b> UP TO 5 PSI CWP MAX			
3/8"	H-22561	12/144	33
1/2"	H-22562	12/144	49
3/4"	H-22563	12/144	64
1"	H-22564	6/72	58



**FULL PORT FORGED BRASS BALL VALVE**  
w/ 1/4" Threaded Gauge Hole (Plugged), Reversible Handle & Adjustable Packing Gland

STANDARD BRASS			
SIZE	ITEM#	CTN/CASE	CASE WT
<b>FIP</b> 600 PSI CWP MAX/150 WSP			
1/2"	H-41722	10/80	43
3/4"	H-41723	10/60	43
1"	H-41724	6/48	56
1 1/4"	H-41725	4/32	56
1 1/2"	H-41726	2/24	64
2"	H-41727	2/16	61



**FULL PORT FORGED BRASS BALL VALVE**  
3 Way L-Port w/ Reversible Handle & Adjustable Packing Gland

STANDARD BRASS			
SIZE	ITEM#	CTN/CASE	CASE WT
<b>FIP</b> 600 PSI CWP MAX/150 WSP			
1/2"	H-40642	15/60	34
3/4"	H-40643	10/40	34
1"	H-40644	6/24	35

**CHROME-PLATED EXTRUDED BRASS MINI BALL VALVE**  
Hex Body

STANDARD BRASS			
SIZE	ITEM#	CTN/CASE	CASE WT
<b>F1807 PEX</b> 110 PSI CWP Max NON-SHOCK			
1/2"	H-40782	30/300	61



# HOSE DRAIN VALVES

MORE WEBSTONE EXCLUSIVES WITH HOSE DRAIN CONNECTIONS FEATURED THROUGHOUT THIS CATALOG



**FULL PORT FORGED BRASS BALL VALVE**  
w/ Cap & Strap, Reversible Handle & Adjustable Packing Gland

**LEAD-FREE BRASS**

Certified to NSF/ANSI 61-G

SIZE	ITEM#	CTN/CASE	CASE WT
<b>FIP × Hose</b>			
1/2" × 3/4"	H-40312W	10/60	30
3/4"	H-40313W	10/60	42
<b>SWT × Hose</b>			
1/2" × 3/4"	H-50312W	10/100	49
3/4"	H-50313W	10/60	42

**LEAD-FREE BRASS**

Certified to NSF/ANSI 61 & 372

SIZE	ITEM#	CTN/CASE	CASE WT
<b>Press × Hose</b>			
1/2" × 3/4"	H-80312W	5/50	29
3/4"	H-80313W	5/40	33

**FORGED BRASS HOSE BIBB**

w/ Ball Valve Action

**LEAD-FREE BRASS**

Certified to NSF/ANSI 61-G

SIZE	ITEM#	CTN/CASE	CASE WT
<b>MIP × Hose</b>			
1/2"	H-30314W	12/72	35
3/4"	H-30316W	12/72	39

1/2" MIP OR SWT × HOSE

**BRASS HOSE BIBB**

No Kink w/ 1/4 Turn Handle

**LEAD-FREE BRASS**

Certified to NSF/ANSI 61-G

SIZE	ITEM#	CTN/CASE	CASE WT
<b>MIP × Hose</b>			
1/2"	H-30218W	12/72	23
3/4"	H-30219W	12/72	26

1/2" MIP OR SWT × HOSE

**FULL FLOW FORGED NICKEL-PLATED BRASS SILLCOCK**

1/4 Turn Action w/ Stainless Steel Lever Handle

**LEAD-FREE BRASS**

SIZE	ITEM#	CTN/CASE	CASE WT
<b>F1960 PEX Flange × MIP Hose</b>			
1/2"	H-33202WSSL	12/72	58

**FORGED BRASS SILLCOCK**

Nickel-Plated w/ 1/4 Turn Handle

**LEAD-FREE BRASS**

SIZE	ITEM#	CTN/CASE	CASE WT
<b>FIP Flange × Hose</b>			
1/2"	H-30202W	12/72	43
3/4"	H-30203W	12/72	59

# GATE VALVES

**FORGED BRASS GATE VALVE**

Hard Seat

**LEAD-FREE BRASS**

Certified to NSF/ANSI 61-G

SIZE	ITEM#	CTN/CASE	CASE WT
<b>FIP</b>			
1/2"	H-10132W	10/100	50
3/4"	H-10133W	10/100	71
1"	H-10134W	5/50	48
1 1/4"	H-10135W	5/30	52
1 1/2"	H-10136W	2/30	63
2"	H-10137W	2/20	58
2 1/2"	H-10138W	1/10	50
3"	H-10139W	1/10	73
4"	H-10140W	1/4	49



# INDEX

PART NUMBER	PAGE	PART NUMBER	PAGE	PART NUMBER	PAGE	PART NUMBER	PAGE	PART NUMBER	PAGE
H-4CC4-NBHK	18	H-10137W	48	H-16803W-R	44	H-26303W	42	H-30616W	28
H-4CCL54-54Y	18	H-10138W	48	H-16803W-R58	44	H-26304W	42	H-30617W	28
H-4FK4-WIF	18	H-10139W	48	H-16804W	44	H-26320W-B	42	H-31000	35
H-4FK5-CH	18	H-10140W	48	H-16804W-R	44	H-26323W	42	H-31403W	36
H-5CC4-NBHK	18	H-10422W	30	H-16804W-RX	44	H-26332W-B	42	H-31403WHV	36
H-5CCL54-54Y	18	H-10423W	30	H-16805W	44	H-26334W-B	42	H-31404W	36
H-5FK4-WIF	18	H-10423W-RB	13	H-16806W	44	H-26343W	42	H-31404WHV	36
H-5FK5-CH	18	H-10424W	30	H-16807W	44	H-26400W-B	42	H-31413W	36
H-7-1102W WP	7, 25	H-10432W	29	H-16823W	45	H-26402W	42	H-31413WHV	36
H-7-1103W WP	7, 25	H-10433W	29	H-16823W-R	45	H-26403W	42	H-31414W	36
H-7-1202W WP	7, 25	H-10434W	29	H-16823W-R58	45	H-26404W	42	H-31414WHV	36
H-7-1203W WP	7, 25	H-10435W	29	H-16824W-RX	45	H-26412W	43	H-31702WSSW	46
H-7-2102W WP	7, 25	H-10436W	29	H-16833W	45	H-26412WHE-B	43	H-31703WSSW	46
H-7-2103W WP	7, 25	H-10437W	29	H-16833W-R	45	H-26413W-B	43	H-31704WSSW	46
H-7-2104W WP	7, 25	H-10540W	24	H-16833W-R58	45	H-26421W-B	42	H-31705WSSW	46
H-7-2165W WP	25	H-10541W	24	H-16842W	44	H-26422W	42	H-31706WSSW	46
H-7-2166W WP	25	H-10542W	24	H-16843W	44	H-26432W	42	H-31707WSSW	46
H-7-2202W WP	7, 25	H-10543W	24	H-16843W-R	44	H-26443W-B	42	H-32000W	7, 25
H-7-2203W WP	7, 25	H-10544W	24	H-16843W-R58	44	H-26462W	43	H-33000W	8
H-7-2204W WP	7, 25	H-10545W	24	H-16844W	44	H-26500W-B	42	H-33202WSSL	48
H-7-3102W WP	7, 25	H-10546W	24	H-16844W-R	44	H-26501W-B	42	H-34063W	12
H-7-3103W WP	7, 25	H-10547W	24	H-16844W-RX	44	H-26502W	42	H-34443W	12
H-7-3202W WP	7, 25	H-10548W	24	H-16845W	44	H-26503W	42	H-34443WPR	12
H-7-3203W WP	7, 25	H-10549W	24	H-16846W	44	H-26504W	42	H-34443WPR-GST	14
H-7-4102W WP	7, 25	H-10550W	24	H-16847W	44	H-26512W-B	42	H-34443WPR-LF	12
H-7-4103W WP	7, 25	H-10612W	28	H-16852W	44	H-26520W-B	42	H-34444W	12
H-7-4104W WP	7, 25	H-10613W	28	H-16852W-BH	44	H-26521W-B	42	H-34444WPR	12
H-7-4165W WP	25	H-10614W	28	H-16853W	44	H-26522W	42	H-34444WPR-LF	12
H-7-4166W WP	25	H-10615W	28	H-16853W-BH	44	H-26532W	42	H-34702WSSW	47
H-7-4202W WP	7, 25	H-10616W	28	H-16854W	44	H-26533W	42	H-34703WSSW	47
H-7-4203W WP	7, 25	H-10617W	28	H-16855W	44	H-26543W	42	H-34704WSSW	47
H-7-4204W WP	7, 25	H-10622W	24	H-18102W	45	H-26601W-B	43	H-36802W	44
H-7-5102W WP	7, 25	H-10623W	24	H-18103W	45	H-26602W	43	H-36803W	44
H-7-5103W WP	25	H-10624W	24	H-18104W	45	H-26603W	43	H-36803W-R	44
H-7-5104W WP	7, 25	H-10625W	24	H-20713	13	H-26604W	43	H-36803W-R58	44
H-7-5165W WP	25	H-10626W	24	H-20713W	13	H-26702W	43	H-36804W	44
H-7-5166W WP	25	H-10627W	24	H-20723-CN	13	H-26703W	43	H-36804W-R	44
H-7-5202W WP	7, 25	H-10741W	24	H-20733	13	H-26820W	43	H-36804W-RX	44
H-7-5203W WP	7, 25	H-10742W	24	H-22442	15	H-26821W	43	H-36805W	44
H-7-5204W WP	7, 25	H-10743W	24	H-22442-24-FP	15	H-26920W	43	H-36806W	44
H-7-6102W WP	7, 25	H-10744W	24	H-22443	15	H-26921W	43	H-36807W	44
H-7-6103W WP	7, 25	H-10745W	24	H-22443-24-FP	15	H-26992W-B	24, 43	H-36823W	45
H-7-6202W WP	7, 25	H-10746W	24	H-22561	47	H-26993W	24, 43	H-36823W-R	45
H-7-6203W WP	7, 25	H-10747W	24	H-22562	47	H-26994W-B	24, 43	H-36823W-R58	45
H-7-7211W WP	8	H-10751W	24	H-22563	47	H-28000-B	43	H-36824W-RX	45
H-7-7610W-TG WP	8	H-10752W	24	H-22564	47	H-28023W	13	H-36833W	45
H-7-7610W WP	8	H-10753W	24	H-26023W-12-B	43	H-28110-B	43	H-36833W-R	45
H-7-8102W WP	7, 25	H-10754W	24	H-26023W-15-B	43	H-28111-B	43	H-36833W-R58	45
H-7-8103W WP	7, 25	H-10755W	24	H-26023W-18	43	H-28112	43	H-36842W	44
H-7-8104W WP	7, 25	H-10756W	24	H-26023W-24-B	43	H-28113	43	H-36843W	44
H-7-8165W WP	25	H-10757W	24	H-26033W-12	43	H-28114	43	H-36843W-R	44
H-7-8166W WP	25	H-10782W	24	H-26033W-15	43	H-28115-B	43	H-36843W-R58	44
H-7-8202W WP	7, 25	H-10783W	24	H-26033W-18	43	H-28116-B	43	H-36844W	44
H-7-8203W WP	7, 25	H-10784W	24	H-26033W-24	43	H-28117-B	43	H-36844W-R	44
H-7-8204W WP	7, 25	H-10785W	24	H-26100W-B	42	H-28212	43	H-36844W-RX	44
H-7-G134WY	7, 25	H-10786W	24	H-26101W	42	H-28213	43	H-36845W	44
H-7-G134WY-A	7, 25	H-10787W	24	H-26102W	42	H-28214	43	H-36846W	44
H-7-G144W-A	7, 25	H-11403W	36	H-26103W	42	H-28215-B	43	H-36847W	44
H-7-G234W-A-KITA	7	H-11403WHV	36	H-26104W	42	H-28216-B	43	H-36852W	44
H-7-G234W-A-KITB	7	H-11404W	36	H-26105W-B	42	H-28217-B	43	H-36852W-BH	44
H-7-G234WB	7, 25	H-11404WHV	36	H-26106W-B	42	H-28303W	45	H-36853W	44
H-7-G234WB-A	7, 25	H-11413W	36	H-26107W-B	42	H-30000W-P	35	H-36853W-BH	44
H-7-G234W-KITA	7	H-11413WHV	36	H-26112W	42	H-30000W-TP	35	H-36854W	44
H-7-G234W-KITB	7	H-11414W	36	H-26120W-B	42	H-30202W	48	H-36855W	44
H-7-G234W-KITD	7	H-11414WHV	36	H-26122W	43	H-30203W	48	H-36856W	44
H-7-G234WR	7, 25	H-11702WSSW	46	H-26132W	42	H-30218W	48	H-36857W	44
H-7-G234WR-A	7, 25	H-11703WSSW	46	H-26133W	43	H-30219W	48	H-38102W	45
H-8CC4-NBHK	18	H-11704WSSW	46	H-26143W	42	H-30314W	48	H-38103W	45
H-8CCL54-54Y	18	H-13703HV	39	H-26144W	43	H-30316W	48	H-38104W	45
H-8FK4-WIF	18	H-13706HV	39	H-26154W-B	42	H-30422W	30	H-40312W	48
H-8FK5-CH	18	H-14063W	12	H-26165W-B	42	H-30423W	30	H-40313W	48
H-01102W	45	H-14443W	12	H-26176W-B	42	H-30423W-RB	13	H-40402	37
H-01103W	45	H-14443WPR	12	H-26202W	42	H-30424W	30	H-40403	37
H-01104W	45	H-14443WPR-GST	14	H-26203W	42	H-30432W	29	H-40403HV	37
H-01105W	45	H-14443WPR-LF	12	H-26204W	42	H-30433W	29	H-40404	37
H-01106W	45	H-14444W	12	H-26212W-B	42	H-30434W	29	H-40404HV	37
H-01107W	45	H-14444WPR	12	H-26220W-B	42	H-30435W	29	H-40405	37
H-01132W	45	H-14444WPR-LF	12	H-26222W	42	H-30436W	29	H-40405HV	37
H-10132W	48	H-14702WSSW	47	H-26223W	42	H-30437W	29	H-40406	37
H-10133W	48	H-14703WSSW	47	H-26232W-B	42	H-30612W	28	H-40406HV	37
H-10134W	48	H-14704WSSW	47	H-26233W-B	42	H-30613W	28	H-40407HV	37
H-10135W	48	H-16802W	44	H-26234W-B	42	H-30614W	28	H-40413	37
H-10136W	48	H-16803W	44	H-26302W	42	H-30615W	28	H-40413HV	37

# INDEX

PART NUMBER	PAGE	PART NUMBER	PAGE	PART NUMBER	PAGE	PART NUMBER	PAGE	PART NUMBER	PAGE
H-40413HVKIT	37	H-41406W	36	H-43724-OH	46	H-50622W	47	H-54444W	12, 19
H-40413KIT	37	H-41406WHV	36	H-43725	46	H-50623W	47	H-54444WPR	12
H-40414	37	H-41407HV-RF400	38	H-43726	46	H-50624W	47	H-54444WPR3	19
H-40414HV	37	H-41407HV-RF475	38	H-43727	46	H-50672W	34	H-54444WPR-LF	12
H-40414HVKIT	37	H-41407WHV	36	H-44063W	12	H-50673W	34	H-54612	28
H-40414KIT	37	H-41413	36	H-44443W	12	H-50674W	34	H-54612W	28
H-40415	37	H-41413HV	36	H-44443WPR	12	H-50675W	34	H-54613	28
H-40415HV	37	H-41413HVKIT	37	H-44443WPR-GST	14	H-50676W	34	H-54613W	28
H-40415HVKIT	37	H-41413KIT	37	H-44443WPR-LF	12	H-50677W	34	H-54614	28
H-40415KIT	37	H-41413W	36	H-44444	19	H-50682	47	H-54614W	28
H-40416	37	H-41413WHV	36	H-44444PR3	19	H-51403	36	H-55443WPR	12
H-40416HV	37	H-41413WHVKIT	37	H-44444W	12, 19	H-51403HV	36	H-55443WPR-LH	12
H-40417HV	37	H-41413WKIT	37	H-44444WPR	12	H-51403W	36	H-58354-53	17
H-40422W	30	H-41414	36	H-44444WPR3	19	H-51403WHV	36	H-58354-54	17
H-40423W	30	H-41414HV	36	H-44444WPR-LF	12	H-51404	36	H-58613	34
H-40423W-RB	13	H-41414HVKIT	37	H-44672	35	H-51404HV	36	H-58614	34
H-40424W	30	H-41414KIT	37	H-45443WPR	12	H-51404W	36	H-58615	34
H-40433	29	H-41414W	36	H-45443WPR-LH	12	H-51404WHV	36	H-58616	34
H-40433W	29	H-41414WHV	36	H-48354-43	17	H-51405	36	H-58643	32
H-40434	29	H-41414WHVKIT	37	H-48354-44	17	H-51405HV	36	H-58644	32
H-40434W	29	H-41414WKIT	37	H-48613	34	H-51405W	36	H-58653	32
H-40435	29	H-41415	36	H-48614	34	H-51405WHV	36	H-58654	32
H-40435W	29	H-41415HV	36	H-48615	34	H-51406	36	H-58655	32
H-40436	29	H-41415HVKIT	37	H-48616	34	H-51406HV	36	H-58754-53	17
H-40436W	29	H-41415KIT	37	H-48754-43	17	H-51406HV-RF375	38	H-58754-54	17
H-40443W	12	H-41415W	36	H-48754-44	17	H-51406W	36	H-58765-55	17
H-40443WPR	12	H-41415WHV	36	H-48765-45	17	H-51406WHV	36	H-58854-53	17
H-40530W	47	H-41415WHVKIT	37	H-48854-43	17	H-51407HV-RF400	38	H-58854-54	17
H-40531W	47	H-41415WKIT	37	H-48854-44	17	H-51407HV-RF475	38	H-58865-55	17
H-40532W	47	H-41416	36	H-48865-45	17	H-51407WHV	36	H-60422W	30
H-40533W	47	H-41416HV	36	H-50312W	48	H-51413	36	H-60423W	30
H-40534W	47	H-41416HV-RF375	38	H-50313W	48	H-51413HV	36	H-60424W	30
H-40562W	23	H-41416W	36	H-50402	37	H-51413HVKIT	37	H-62023W-18	43
H-40563W	23	H-41416WHV	36	H-50403	37	H-51413KIT	37	H-62033W-18	43
H-40564W	23	H-41417HV-RF400	38	H-50403HV	37	H-51413W	36	H-62702W	42
H-40565W	23	H-41417HV-RF475	38	H-50404	37	H-51413WHV	36	H-62703W	42
H-40566W	23	H-41417WHV	36	H-50404HV	37	H-51413WHVKIT	37	H-62704W	42
H-40567W	23	H-41562W	29	H-50405	37	H-51413WKIT	37	H-64063W	12
H-40612	28	H-41563W	29	H-50405HV	37	H-51414	36	H-64443W	12
H-40612W	28	H-41564W	29	H-50406	37	H-51414HV	36	H-64443WPR	12
H-40613	28	H-41565W	29	H-50406HV	37	H-51414HVKIT	37	H-64443WPR-GST	14
H-40613W	28	H-41672	35	H-50407HV	37	H-51414KIT	37	H-64443WPR-LF	12
H-40614	28	H-41685	47	H-50413	37	H-51414W	36	H-70000W	6, 25
H-40614W	28	H-41686	47	H-50413HV	37	H-51414WHV	36	H-70000W-CAN	6, 25
H-40615	28	H-41687	47	H-50413HVKIT	37	H-51414WHVKIT	37	H-70060W	6, 25
H-40615W	28	H-41698	47	H-50413KIT	37	H-51414WKIT	37	H-70070W	6, 25
H-40616	28	H-41699	47	H-50414	37	H-51415	36	H-70530	24, 25
H-40616W	28	H-41700	46	H-50414HV	37	H-51415HV	36	H-70530-A	24, 25
H-40617	28	H-41700W	46	H-50414HVKIT	37	H-51415HVKIT	37	H-70540	24, 25
H-40617W	28	H-41701	46	H-50414KIT	37	H-51415KIT	37	H-70540-A	24, 25
H-40622W	47	H-41701W	46	H-50415	37	H-51415W	36	H-70700	22, 25
H-40623W	47	H-41702	46	H-50415HV	37	H-51415WHV	36	H-70706	23, 25
H-40624W	47	H-41702W	46	H-50415HVKIT	37	H-51415WHVKIT	37	H-71000-V	20, 25
H-40632W	46	H-41702WSSW	46	H-50415KIT	37	H-51415WKIT	37	H-71202W	6
H-40633W	46	H-41703	46	H-50416	37	H-51416	36	H-71202W-CAN	6
H-40634W	46	H-41703W	46	H-50416HV	37	H-51416HV	36	H-71203W	6
H-40642	47	H-41703WSSW	46	H-50417HV	37	H-51416HV-RF375	38	H-71203W-CAN	6
H-40643	47	H-41704	46	H-50422W	30	H-51416W	36	H-71272W	6
H-40644	47	H-41704W	46	H-50423W	30	H-51416WHV	36	H-71273W	6
H-40782	47	H-41704WSSW	46	H-50423W-RB	13	H-51417HV-RF400	38	H-72003-V	20
H-40800W	46	H-41705	46	H-50424W	30	H-51417HV-RF475	38	H-72004-V	20
H-40801W	46	H-41705W	46	H-50433	29	H-51417WHV	36	H-72202W	6
H-40802W	46	H-41706	46	H-50433W	29	H-51702	46	H-72202W-CAN	6
H-40803W	46	H-41706W	46	H-50434	29	H-51702W	46	H-72203W	6
H-40804W	46	H-41707	46	H-50434W	29	H-51703	46	H-72203W-CAN	6
H-40805W	46	H-41707W	46	H-50435	29	H-51703W	46	H-72204W	6
H-40806W	46	H-41722	47	H-50435W	29	H-51704	46	H-72204W-CAN	6
H-40807W	46	H-41723	47	H-50436	29	H-51704W	46	H-72262W	6
H-41403	36	H-41724	47	H-50436W	29	H-51705	46	H-72263W	6
H-41403HV	36	H-41725	47	H-50443W	12	H-51705W	46	H-72264W	6
H-41403W	36	H-41726	47	H-50443WPR	12	H-51706	46	H-72272W	6
H-41403WHV	36	H-41727	47	H-50612	28	H-51706W	46	H-72273W	6
H-41404	36	H-42443W	13	H-50612W	28	H-51707	46	H-72274W	6
H-41404HV	36	H-42443WPR	13	H-50613	28	H-51707W	46	H-72533	24
H-41404W	36	H-42443WPR-GST	14	H-50613W	28	H-52443W	13	H-72533-A	24
H-41404WHV	36	H-42443WPR-LF	13	H-50614	28	H-52443WPR	13	H-72544	24
H-41405	36	H-43720	46	H-50614W	28	H-52443WPR-GST	14	H-72544-A	24
H-41405HV	36	H-43721	46	H-50615	28	H-52443WPR-LF	13	H-72703	22
H-41405W	36	H-43722	46	H-50615W	28	H-54063W	12	H-72704	22
H-41405WHV	36	H-43722-OH	46	H-50616	28	H-54443W	12	H-72705	23
H-41406	36	H-43723	46	H-50616W	28	H-54443WPR	12	H-72706	23
H-41406HV	36	H-43723-OH	46	H-50617	28	H-54443WPR-GST	14	H-72713	22
H-41406HV-RF375	38	H-43724	46	H-50617W	28	H-54443WPR-LF	12	H-72714	22



# INDEX

PART NUMBER	PAGE	PART NUMBER	PAGE	PART NUMBER	PAGE	PART NUMBER	PAGE	PART NUMBER	PAGE
H-73202W-CE	6	H-77411W	8	H-80646W	33	H-81708W	46	H-91415WHV	40
H-73202W-CE-CAN	6	H-77411W-TG	8	H-80647W	33	H-81709W	46	H-91416WHV	40
H-73203W-CE	6	H-77610W	8	H-80672W	34	H-81710W	46	H-91417WHV	40
H-73203W-CE-CAN	6	H-77610W-TG	8	H-80673W	34	H-82672W	32	H-91702W	40
H-73272W	6	H-78003	21	H-80674W	34	H-82672W-T34	32	H-91703W	40
H-73273W	6	H-78003-V	20	H-80675W	34	H-82673W	32	H-91704W	40
H-74000	21	H-78004	21	H-80742W	33	H-82712W	31	H-91705W	40
H-74003	21	H-78004-V	20	H-80743W	33	H-82713W	31	H-91706W	40
H-74003-V	20	H-78005	21	H-80744W	33	H-82714W	31	H-91707W	40
H-74004	21	H-78006	21	H-80745W	33	H-83612W	28	H-94702W	40
H-74004-V	20	H-78007	21	H-80746W	33	H-83613W	28	H-94703W	40
H-74005	21	H-78202W	6	H-80747W	33	H-83614W	28	H-94704W	40
H-74006	21	H-78202W-CAN	6	H-81102W	45	H-83615W	28	H-94705W	40
H-74007	21	H-78203W	6	H-81103W	45	H-83616W	28	H-94706W	40
H-74202W	6	H-78203W-CAN	6	H-81104W	45	H-83617W	28	H-94707W	40
H-74202W-CAN	6	H-78204W	6	H-81403	36	H-83712W	31	H-100613W	41
H-74203W	6	H-78204W-CAN	6	H-81403HV	36	H-83713W	31	H-100614W	41
H-74203W-CAN	6	H-78262W	6	H-81403W	36	H-83713W-T114	31	H-100615W	41
H-74204W	6	H-78263W	6	H-81403WHV	36	H-83714W	31	H-100616W	41
H-74204W-CAN	6	H-78264W	6	H-81404	36	H-83714W-T112	31	H-100617W	41
H-74262W	6	H-78272W	6	H-81404HV	36	H-83714W-T114	31	H-101403WHV	41
H-74263W	6	H-78273W	6	H-81404W	36	H-83715W-T112	31	H-101404WHV	41
H-74264W	6	H-78274W	6	H-81404WHV	36	H-84063W	12	H-101405WHV	41
H-74272W	6	H-78313W	9	H-81405	36	H-84443W	12	H-101406WHV	41
H-74273W	6	H-78323W	9	H-81405HV	36	H-84443WPR	12	H-101407WHV	41
H-74274W	6	H-78533	24	H-81405W	36	H-84443WPR-GST	14	H-101413WHV	41
H-74303W	9	H-78533-A	24	H-81405WHV	36	H-84443WPR-LF	12	H-101414WHV	41
H-74303W-KITA	9	H-78544	24	H-81406	36	H-84444W	12, 19	H-101415WHV	41
H-74303W-KITB	9	H-78544-A	24	H-81406HV	36	H-84444WPR	12	H-101416WHV	41
H-74313W	9	H-78703	22	H-81406HV-RF375	38	H-84444WPR3	19	H-101417WHV	41
H-74313W-KITA	9	H-78704	22	H-81406W	36	H-84444WPR-LF	12	H-101702W	41
H-74313W-KITB	9	H-78705	23	H-81406WHV	36	H-84613	28	H-101703W	41
H-74323W	9	H-78706	23	H-81407HV	36	H-84614	28	H-101704W	41
H-74533	24	H-78713	22	H-81407HV-RF400	38	H-85443WPR	12	H-101705W	41
H-74533-A	24	H-78714	22	H-81407HV-RF475	38	H-85443WPR-LH	12	H-101706W	41
H-74544	24	H-80132W	47	H-81407WHV	36	H-86152W	44	H-101707W	41
H-74544-A	24	H-80133W	47	H-81413	36	H-86153W	44	H-104702W	41
H-74703	22	H-80134W	47	H-81413HV	36	H-86153W-R	44	H-104703W	41
H-74704	22	H-80135W	47	H-81413HVKIT	37	H-86154W	44	H-104704W	41
H-74705	23	H-80136W	47	H-81413W	36	H-86154W-R	44	H-104705W	41
H-74706	23	H-80137W	47	H-81413WHV	36	H-86155W	44	H-104706W	41
H-74713	22	H-80312W	48	H-81414	36	H-86352W	44	H-104707W	41
H-74714	22	H-80313W	48	H-81414HV	36	H-86353W	44	H-C7-303	7, 25
H-75003	21	H-80332W	47	H-81414HVKIT	37	H-86353W-R	44	H-FSTR4-54	23
H-75003-V	20	H-80333W	47	H-81414W	36	H-86354W	44	H-FSTR5-55	23
H-75004	21	H-80334W	47	H-81414WHV	36	H-86354W-R	44	H-G0673W	9
H-75004-V	20	H-80335W	47	H-81415	36	H-86355W	44	H-G1404W	7, 25
H-75005	21	H-80336W	47	H-81415HV	36	H-86356W	44	H-G1404W-A-KITB	7
H-75006	21	H-80337W	47	H-81415HVKIT	37	H-86357W	44	H-G1404WHV	7, 25
H-75007	21	H-80422W	30	H-81415W	36	H-86452W	44	H-G1404W-KITB	7
H-75202W	6	H-80423W	30	H-81415WHV	36	H-86452W-R	44	H-G1414W	7, 25
H-75202W-CAN	6	H-80423W-RB	13	H-81416	36	H-86453W	44	H-G1414W-A-KITB	7
H-75203W	6	H-80424W	30	H-81416HV	36	H-86453W-R	44	H-G1414WHV	7, 25
H-75203W-CAN	6	H-80433W	29	H-81416HV-RF375	38	H-86453W-R14	44	H-G1414W-KITB	7
H-75204W	6	H-80434W	29	H-81416W	36	H-86454W-R12	44	H-HCE4-43	19
H-75204W-CAN	6	H-80435W	29	H-81416WHV	36	H-88354-43	17	H-HCE4-44	19
H-75262W	6	H-80436W	29	H-81417HV	36	H-88354-44	17	H-HCE4-53	19
H-75263W	6	H-80562W	23	H-81417HV-RF400	38	H-88613	34	H-HCE4-54	19
H-75264W	6	H-80563W	23	H-81417HV-RF475	38	H-88614	34	H-HCE4-63	19
H-75272W	6	H-80564W	23	H-81417WHV	36	H-88615	34	H-HCE4-64	19
H-75273W	6	H-80565W	23	H-81424HV	39	H-88616	34	H-HCE4-73	19
H-75274W	6	H-80566W	23	H-81562W	29	H-88643	32	H-HCE4-74	19
H-75533	24	H-80567W	23	H-81563W	29	H-88644	32	H-HCE4-94	19
H-75533-A	24	H-80612	28	H-81564W	29	H-88654	32	H-HCE5-44	19
H-75544	24	H-80612W	28	H-81565W	29	H-88655	32	H-HCE5-45	19
H-75544-A	24	H-80613	28	H-81612W	28	H-88754-43	17	H-HCE5-54	19
H-75703	22	H-80613W	28	H-81613W	28	H-88754-44	17	H-HCE5-55	19
H-75704	22	H-80614	28	H-81614W	28	H-88765-45	17	H-HCE5-64	19
H-75705	23	H-80614W	28	H-81615W	28	H-88854-43	17	H-HCE5-65	19
H-75706	23	H-80615	28	H-81616W	28	H-88854-44	17	H-HCE5-74	19
H-75713	22	H-80615W	28	H-81617W	28	H-88865-45	17	H-HCE5-75	19
H-75714	22	H-80616	28	H-81702	46	H-90613W	40	H-SE-91413	40, 41
H-76202W	6	H-80616W	28	H-81702W	46	H-90614W	40	H-SE-91414	40, 41
H-76202W-CAN	6	H-80617	28	H-81703	46	H-90615W	40	H-SE-91415	40, 41
H-76203W	6	H-80617W	28	H-81703W	46	H-90616W	40	H-SE-91416	40, 41
H-76203W-CAN	6	H-80633W-T114	30	H-81704	46	H-90617W	40	H-SE-91702	40, 41
H-77201W	8	H-80634W-T112	30	H-81704W	46	H-91403WHV	40	H-SE-91704	40, 41
H-77201W-T	8	H-80634W-T114	30	H-81705	46	H-91404WHV	40	H-SE-91705	40, 41
H-77201W-TG	8	H-80635W-T112	30	H-81705W	46	H-91405WHV	40	H-SE-91706	40, 41
H-77211W	8	H-80642W	33	H-81706	46	H-91406WHV	40	H-SE-91707	40, 41
H-77211W-TG	8	H-80643W	33	H-81706W	46	H-91407WHV	40		
H-77401W	8	H-80644W	33	H-81707	46	H-91413WHV	40		
H-77401W-TG	8	H-80645W	33	H-81707W	46	H-91414WHV	40		

# Webstone<sup>®</sup>

a brand of **NIBCO<sup>®</sup>**

**VALVE INNOVATION**  
**INSTALLATION SOLUTIONS**

**800-225-9529**

[www.webstonevalves.com](http://www.webstonevalves.com)

